

X-ray Tomography of the Antikythera Mechanism

Andrew Ramsey
Nikon Metrology UK Ltd
(formerly X-Tek Systems Ltd)

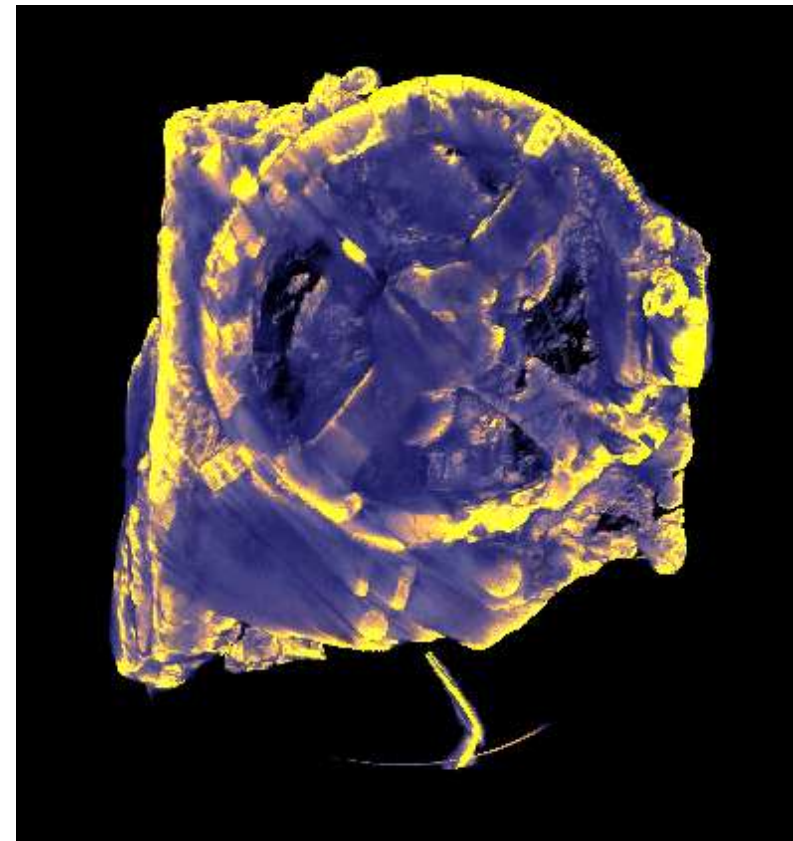

X-ray Tomography of the Antikythera Mechanism

- The history of the Antikythera Mechanism
- Who were X-Tek and how did we get involved?
- Computed Tomography – What is it?
- Why is our CT different to medical CT?
- Microfocus X-ray sources – how do we magnify?
- High energy X-ray sources – how can we see through metal?
- Previous X-ray studies of the Mechanism
- What equipment did we use?
- How can we see buried features using CT?
- The findings... What is the Mechanism?

Ancient Greece

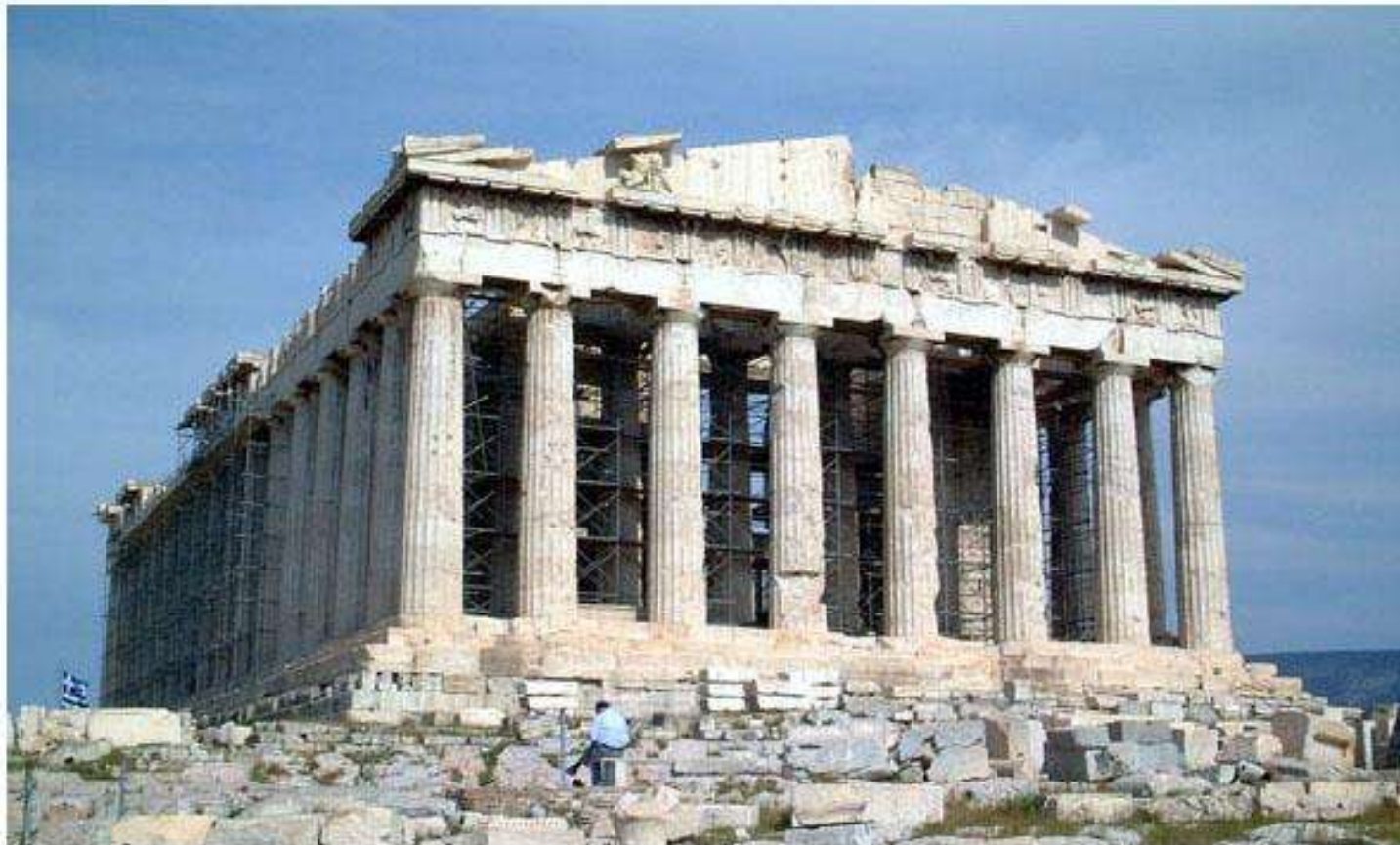

From 776BC to 146BC the ancient Greeks dominated Mediterranean lands

The Ancient Greeks were masters in many of the arts and sciences...



Ancient Greek Computing???

In 1900 sponge divers sheltered from a storm just off the island of Antikythera (the one before Kythera!) in the Mediterranean between Crete and Greece. Afterwards they decided to dive and found an ancient shipwreck – a veritable treasure-ship. As well as dozens of marble and bronze statues, jewellery and other loot, they found a small wooden box.



The box lay in a cupboard in the National Archaeological Museum in Athens and wasn't studied well until 1950 when an Englishman, Derek de Solla Price* studied it. Inside the rapidly decaying box he found the remains of a bronze geared mechanism of remarkable workmanship.

After many years of studying the numbers of teeth on the gear wheels Price formed the theory that the Antikythera Mechanism was an early astronomical computing machine.

Was this the world's first computer?



* Scientific American, June 1959, pp. 60-67

The ship was Roman, but was full of Greek treasure.



Antikythera

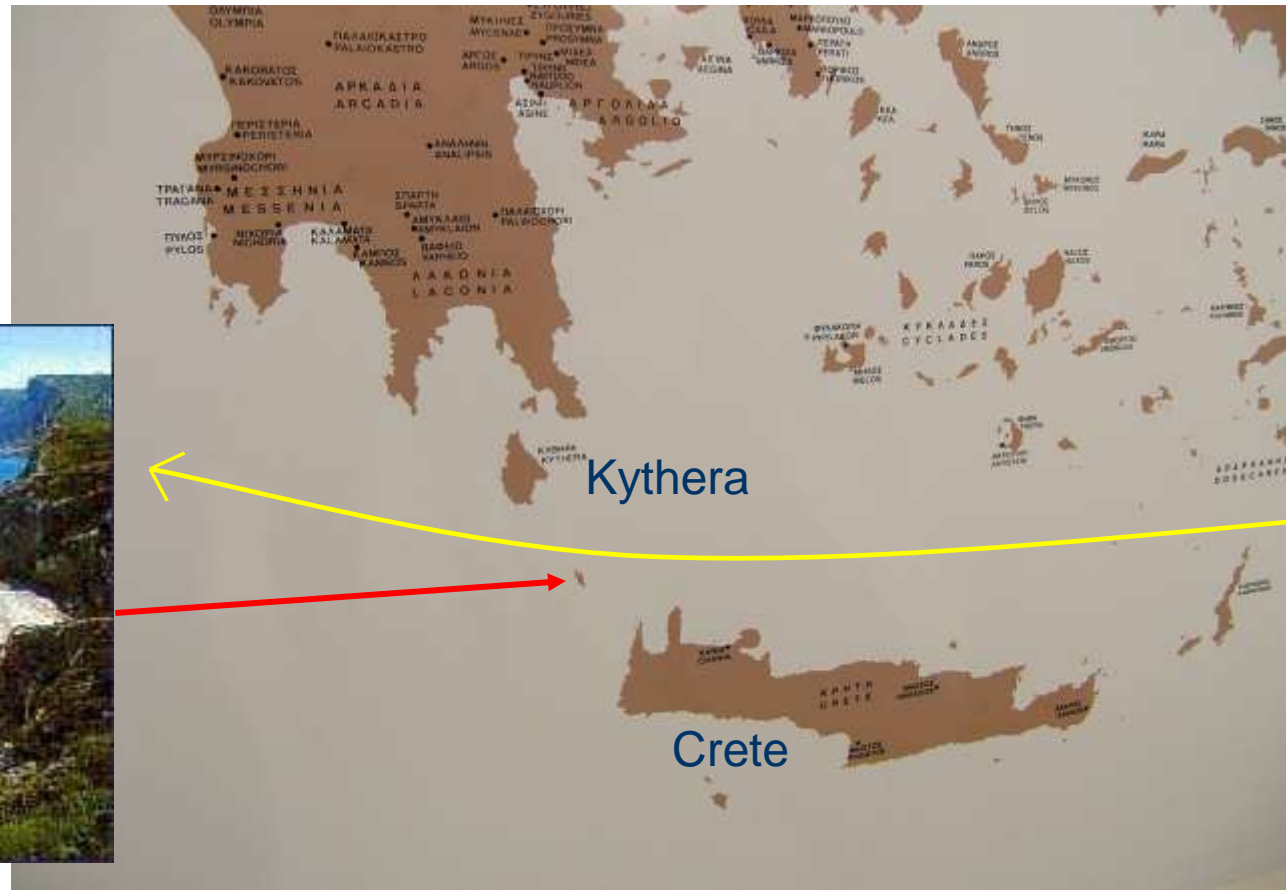

Was it on its way from Rhodes to Rome?

“...the orrery recently constructed by our friend Posidonius, which at each revolution reproduces the motion of the sun, the moon and the five planets that take place in the heavens every day and night...”

Marcus Tullius Cicero, *De Natura Deorum*, ~79 BC

Picture courtesy of “Mediterranean Archaeology and Archaeometry”, Vol. 2, No. 2, pp.45-58 by Tony Freeth

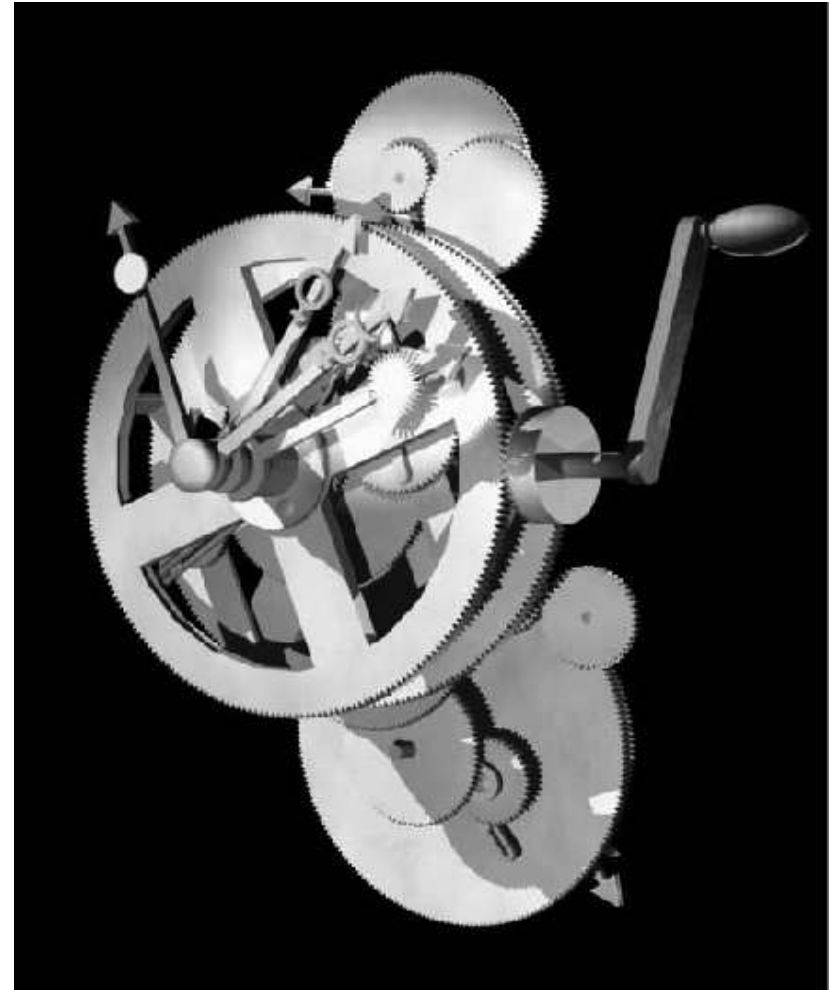

Who are Metris X-Tek and how did we get involved?

- X-Tek was a small family-owned company based in Tring in Great Britain.
- It is now part of Nikon Metrology, owned by Nikon Corporation, Japan.
- In Tring we design and manufacture X-ray inspection equipment, for both real-time imaging (live X-ray images) and 3D CT (= Computed Tomography)



The small market town of Tring



Who are Metris?



- The X-ray arm of Nikon, formerly X-Tek Systems Ltd, is based in Tring, 50km north-west of London.
- X-Tek was founded in 1986 by Roger Hadland.
- Employs around 90 staff, now* part of the >600-strong Nikon Metrology, owned by Nikon Corporation, Japan.
- Design and manufacture microfocus X-ray sources.
- Build and sell complete X-ray inspection systems worldwide.
- Real-time radiography (2D) and computed tomography (3D).
- Main customers: electronics, defence, automotive, aerospace, materials research, failure analysis labs, co-ordinate measurement.



Nikon offices, Tring, in 2012

* Metris bought X-Tek in December 2007
Nikon bought Metris in September 2009.

X-Tek – How did we get involved?

- First approached by Tony Freeth, a freelance film-maker based in London, in 2000.
- Aware of our high-resolution computed tomography (CT) expertise.
- Tony asked could we do this and did we want to get involved?
- X-Tek sales staff: “Of course!”
- Tony: “When I get the funding...”

5 years later:

- But when Roger and our R&D team finally looked into what the mechanism comprised, they realised we needed to do quite a bit of development work!



Tony Freeth



Roger Hadland

What imaging technique did we use and why is it new?

- We used Microfocal X-ray Computed Tomography (known as “ μ CT”).
- Most people’s experience of CT is in a medical CT scanner in a hospital:



In a medical CT scanner the priorities are:

- fast scan speed;
- low X-ray dose to patient;
- good views of organic material.

What is different about X-Tek's μ CT?

- X-Tek's Microfocal Computed Tomography differs from standard medical X-ray imaging in that it has:



- a much smaller spot size (down to $1\mu\text{m}$) – allows magnification.
- much higher energy X-rays (medical: 70kV, we can use up to 450kV) and no limit on dose.
- a more sensitive detector – so we can see more subtle differences.
- a more precise sample manipulator – for better alignment during reconstruction.

What are X-rays?

- X-rays are electromagnetic radiation just like visible light, infra-red light, ultra-violet light and radio waves, but with a much shorter wavelength than any of these.

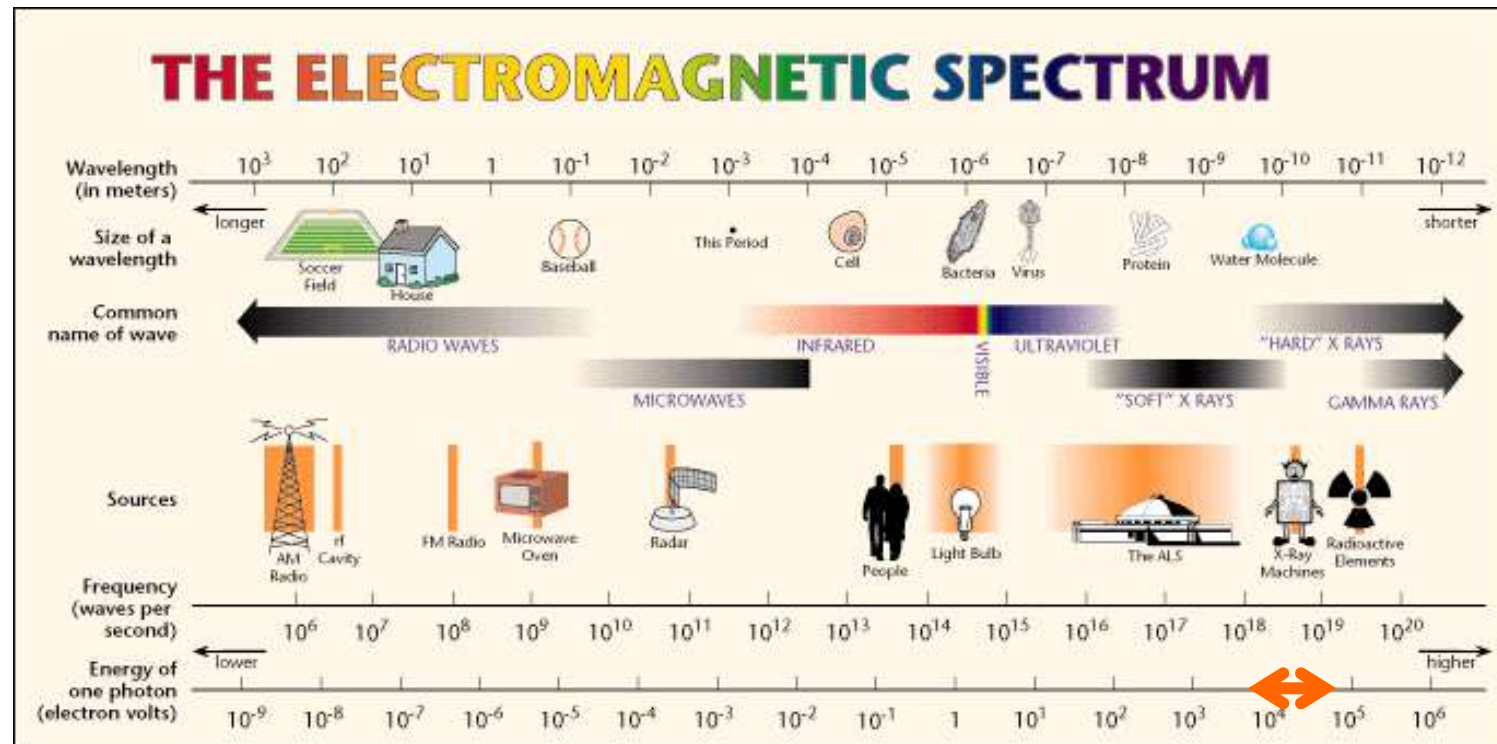

X-Tek X-ray sources produce energies in the range 30-450keV (in red).

How do we generate X-rays?

- We generate X-rays by firing electrons at high speed on to a metal target.
- Electrons are produced from a hot filament (like a light bulb).
- They are accelerated using a high voltage into a beam tube.
- They travel at up to 80% the speed of light (giving them energies of 30 - 450keV).
- They are focused by a magnetic lens into a small spot (1 – 5 μ m) onto a metal target.
- The sudden deceleration of the charged electrons when they hit the target produces 99.3% heat and 0.7% X-rays.

How we generate X-rays:

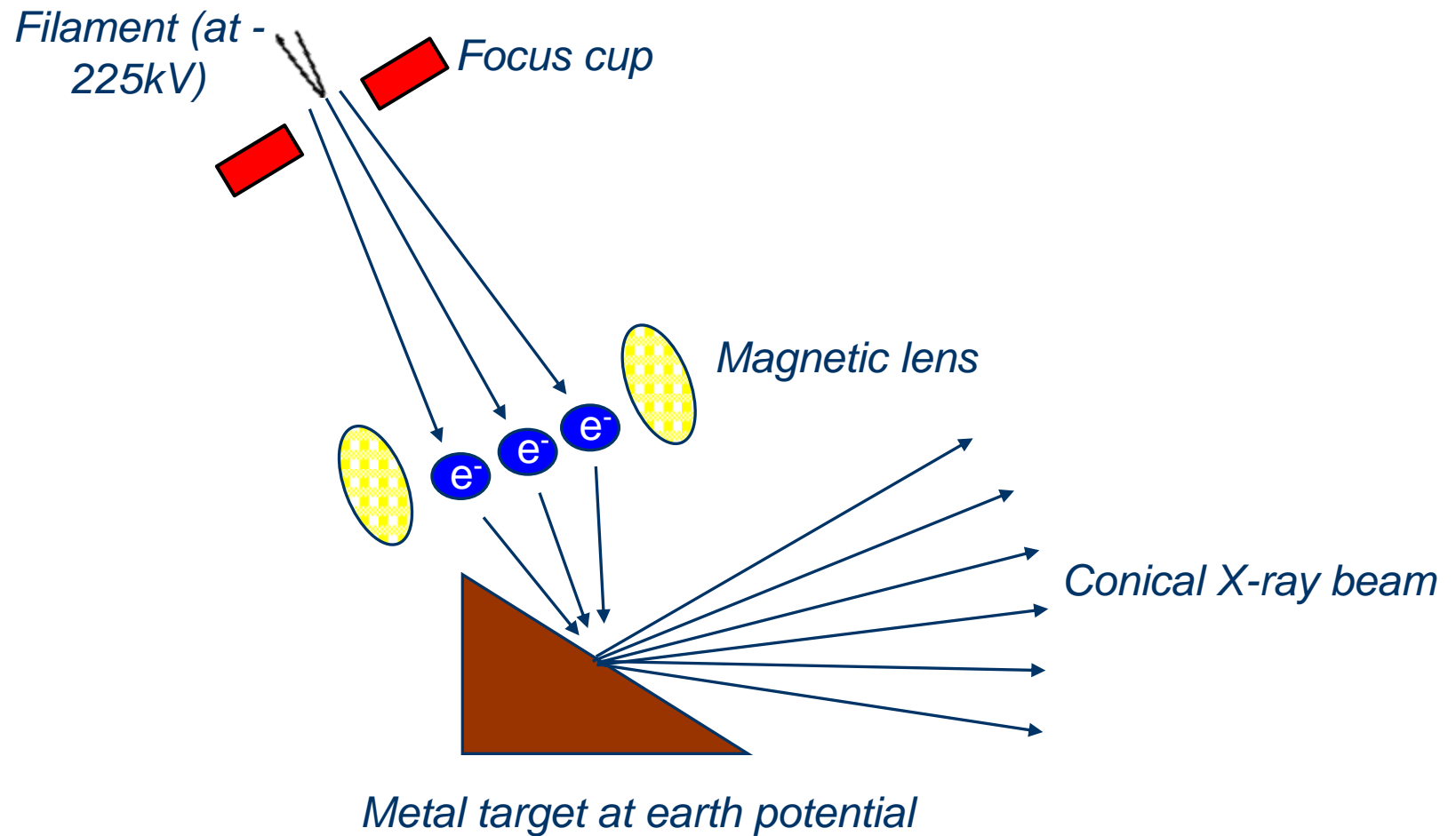

How do we magnify the image?

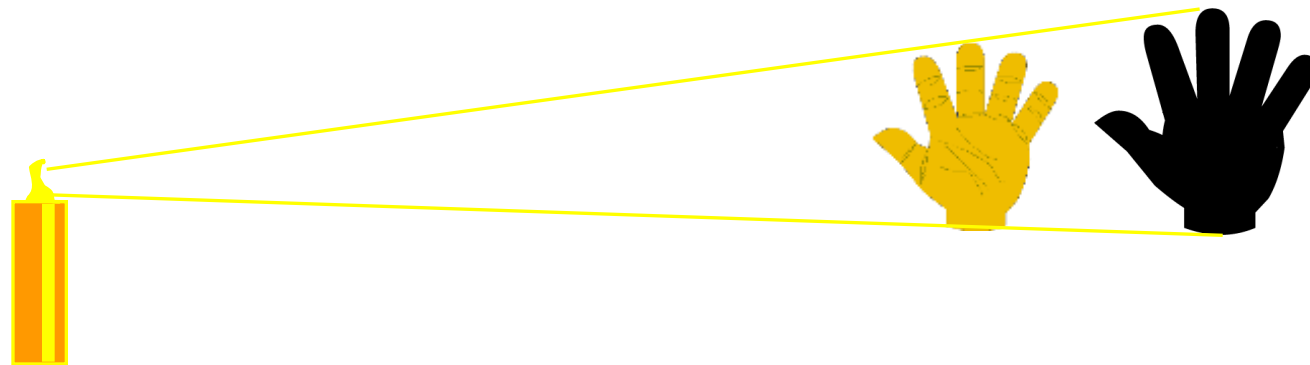

Just like light, X-rays travel in straight lines.
Unlike light, we cannot use a lens,
so we use geometric magnification

How do we magnify the image?

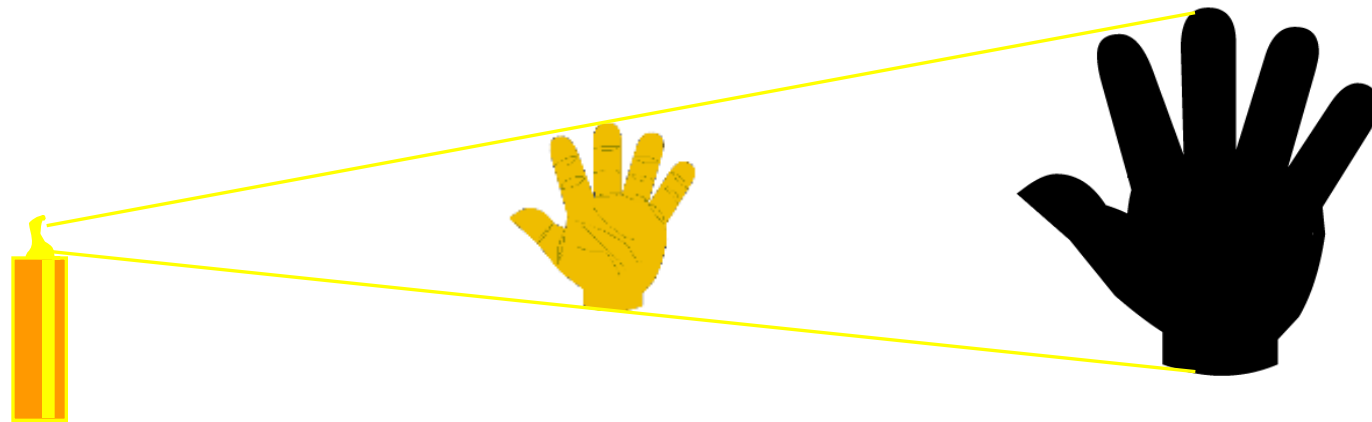

Just like light, X-rays travel in straight lines.
Unlike light, we cannot use a lens,
so we use geometric magnification

How do we magnify the image?

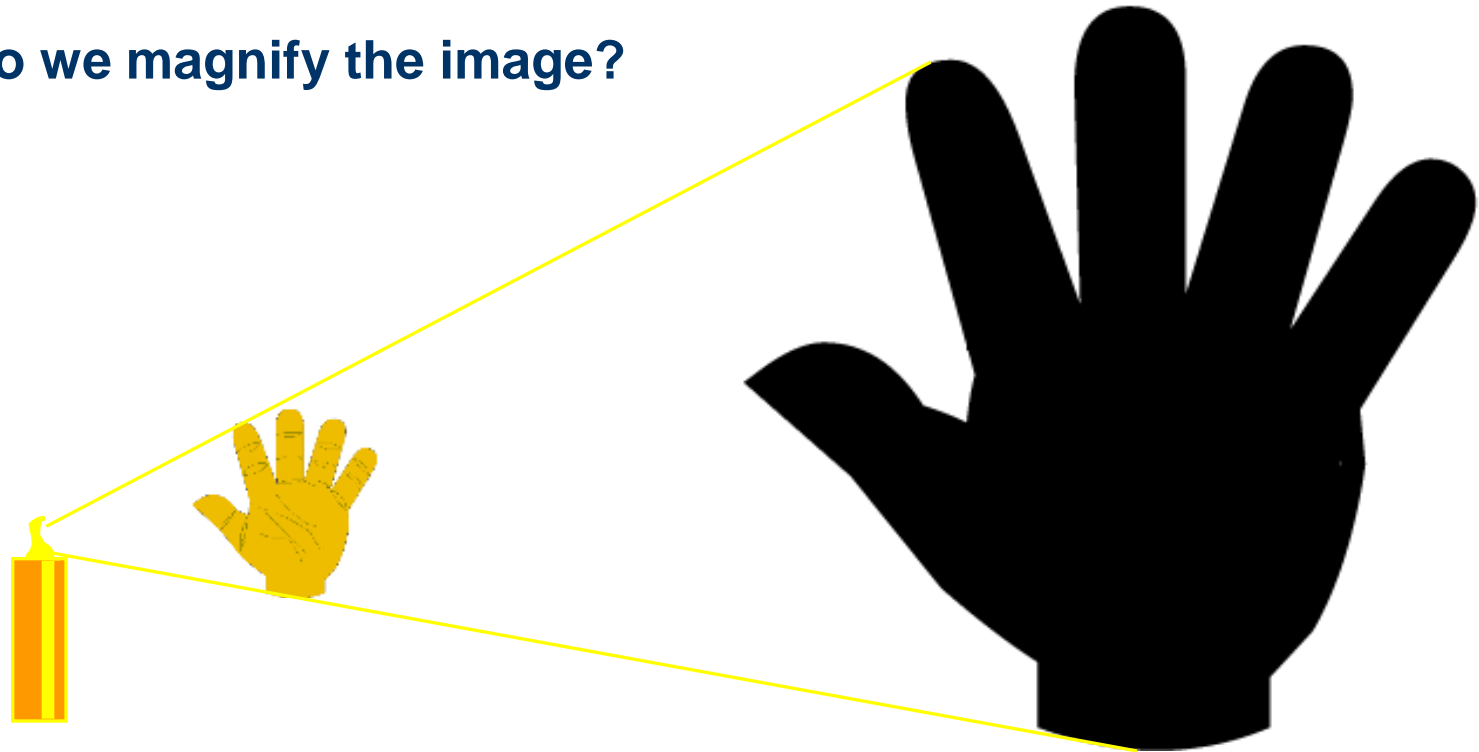

Just like light, X-rays travel in straight lines.
Unlike light, we cannot use a lens,
so we use geometric magnification

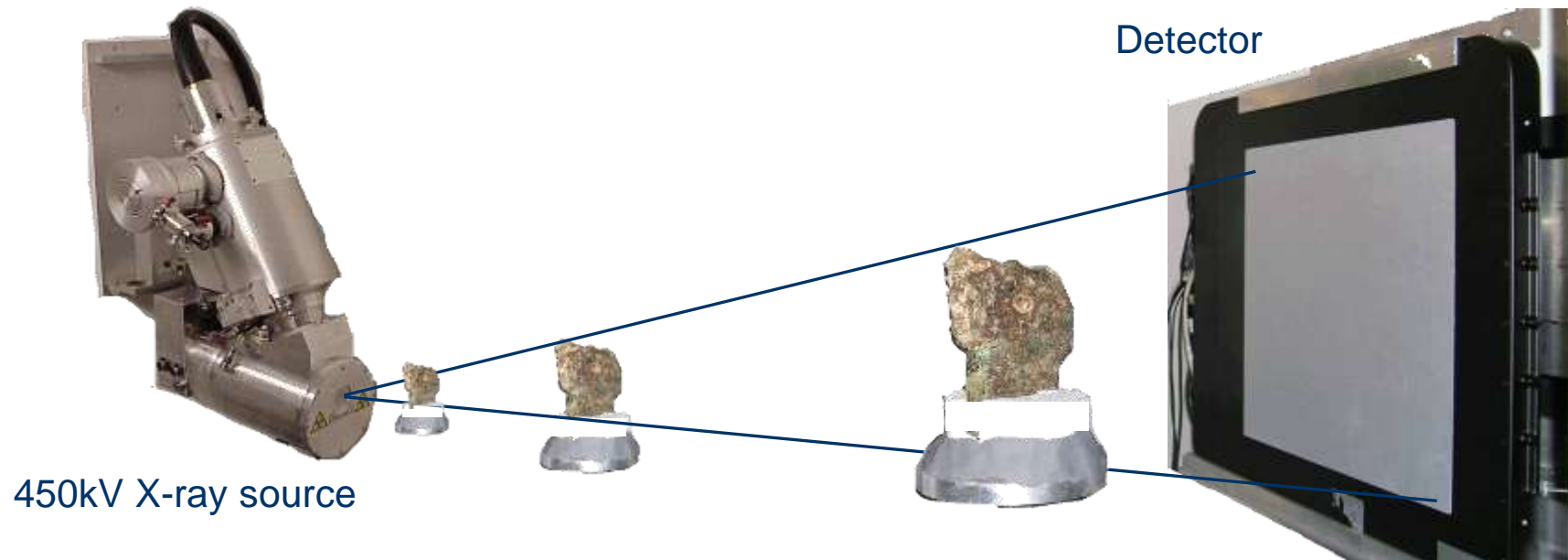

The magnification can be increased by moving the sample closer to the X-ray source.

What is microfocus X-ray computed tomography?

- Microfocus means that the size of the X-ray source is only a few microns across (1 micron or $1\mu\text{m}$ is $1/1000^{\text{th}}$ of one millimetre).
- Using a small X-ray source means that we can magnify the X-ray images on to the detector and thus see more detail.

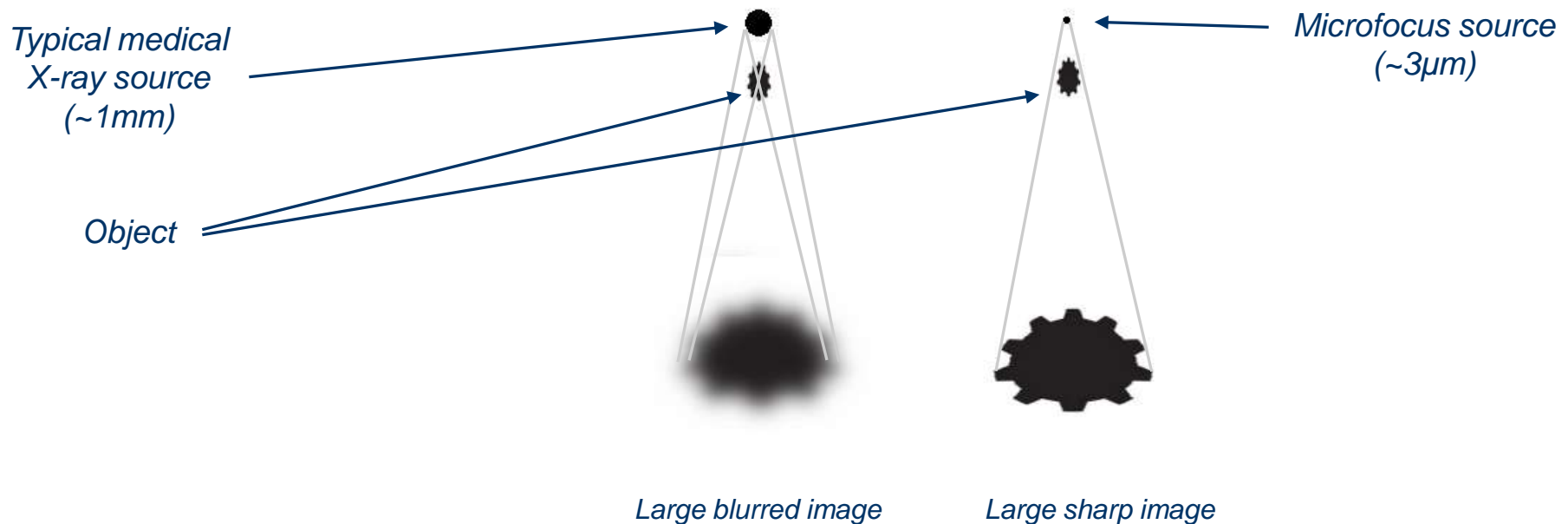

How do we keep the image sharp when we magnify?

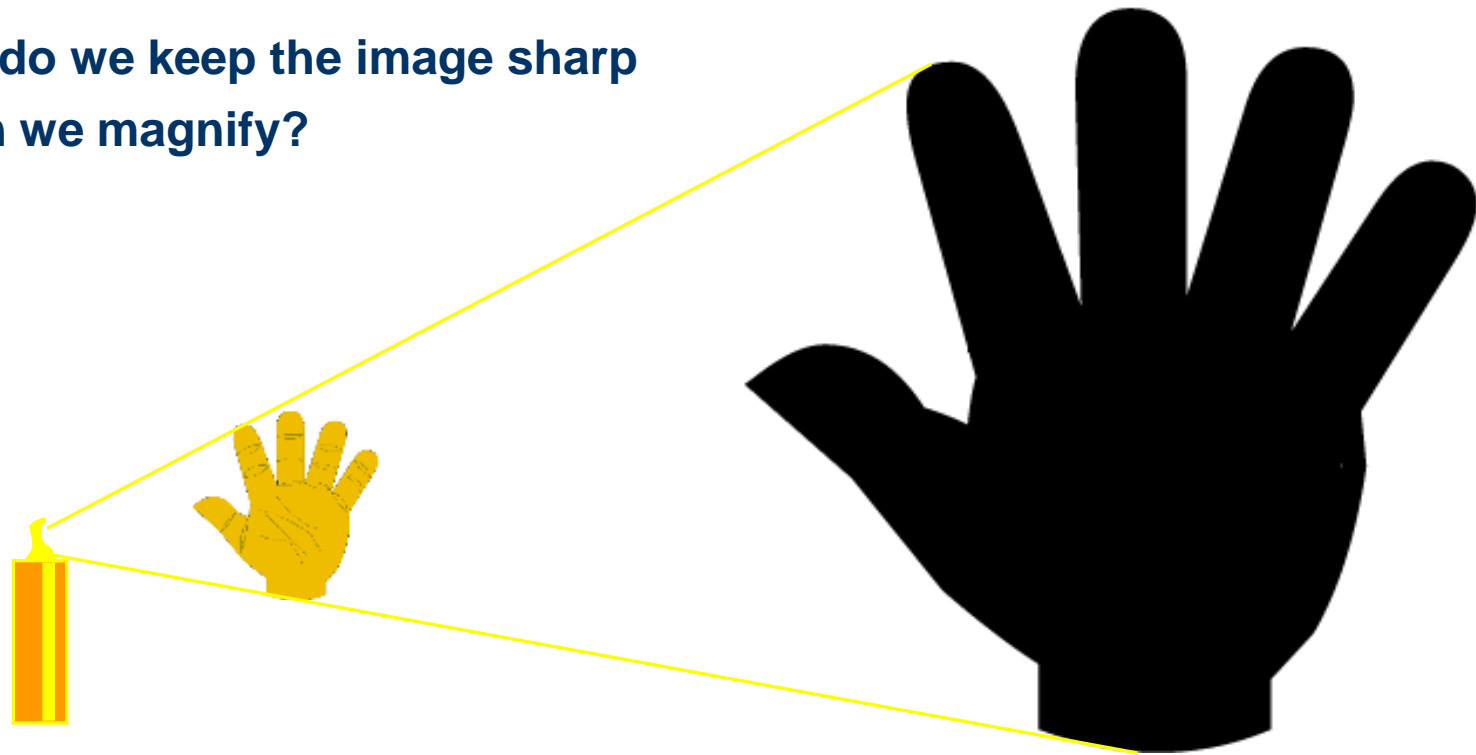

An optical analogy here is the difference between the shadow cast by a small light source, such as a candle and that cast by a larger light source, such as a window.

How do we keep the image sharp when we magnify?

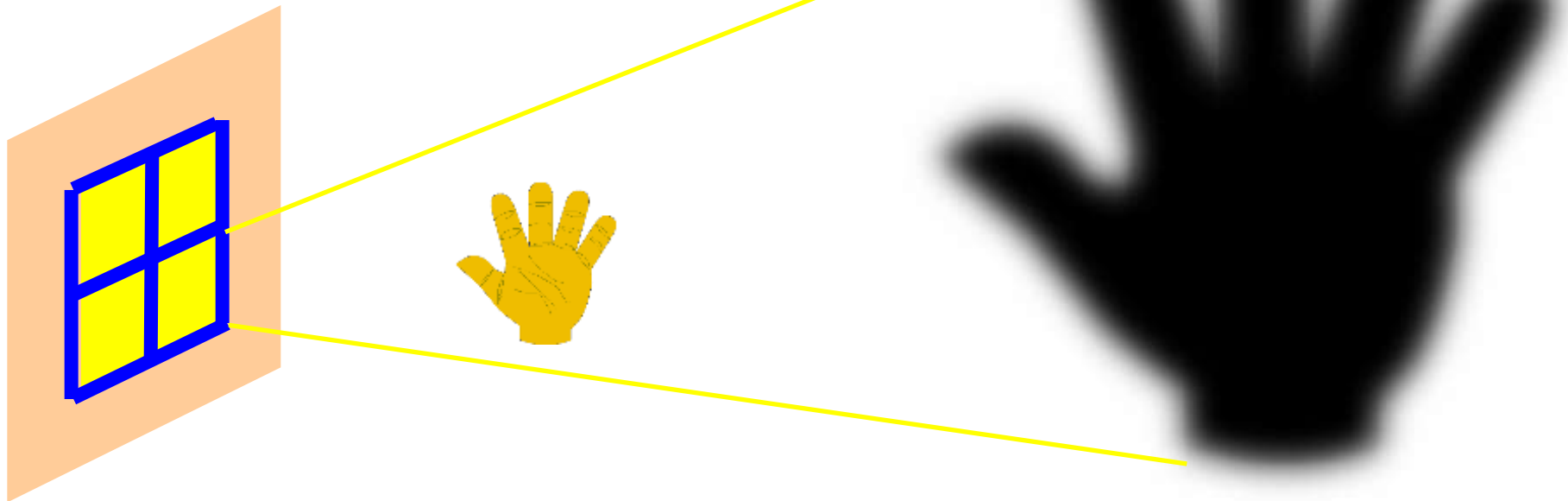

An optical analogy here is the difference between the shadow cast by a small light source, such as a candle and that cast by a larger light source, such as a window.

Why do we need higher energy X-rays?

- Medical X-rays typically have energies of 70 – 140kV.
- They can penetrate bone but are stopped by only a few mm of metal.
- The Mechanism is made of bronze and the largest fragment is ~120mm across.
- So much higher energy X-rays are needed.
- Nikon (X-Tek) is the only company in the world which has a microfocus X-ray source which can generate X-rays with such penetrating power.



Wilhelm Röntgen's first radiograph (1895): the low energy X-rays penetrated the bone but not the gold ring.

How do we image the X-rays?

- The magnified shadow of the object is imaged using an amorphous silicon flat panel detector which comprises:
- a 400x400mm fluorescent screen which converts the X-ray energy into light to form an image,
- an array of 2000x2000 light-sensitive diodes, each 200x200 μ m in size.
- electronics to allow this image to be read by the computer with a precision of 1 part in 65536 (16 bits).



*A 2k x 2k 16-bit panel
kindly lent to us by
PerkinElmer, later
purchased.*

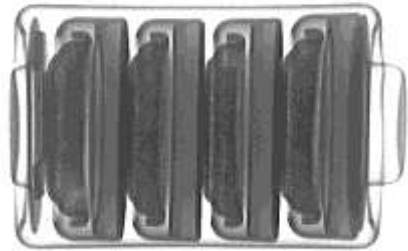

Battery

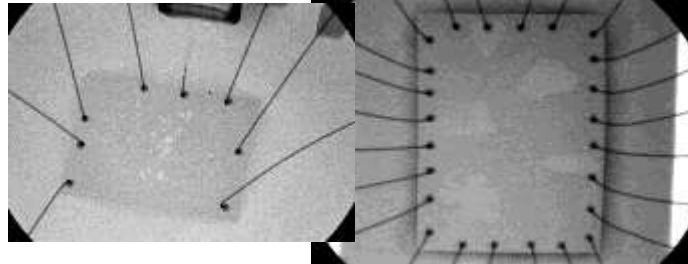

Electronics

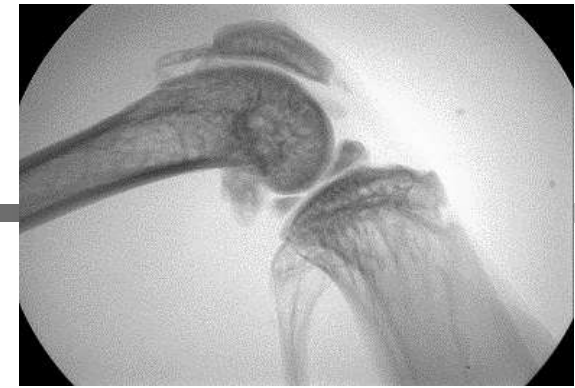

Medical



Seam at the top of a drinks can

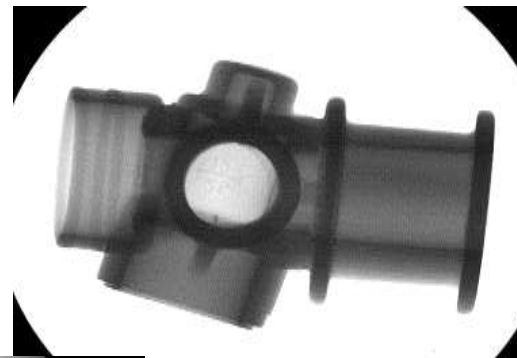

Castings

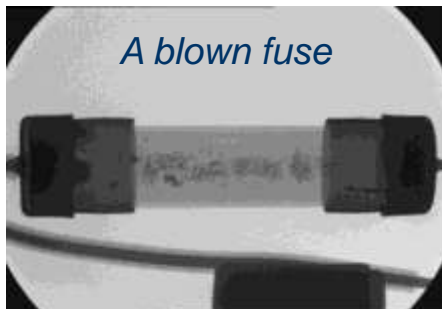

A blown fuse

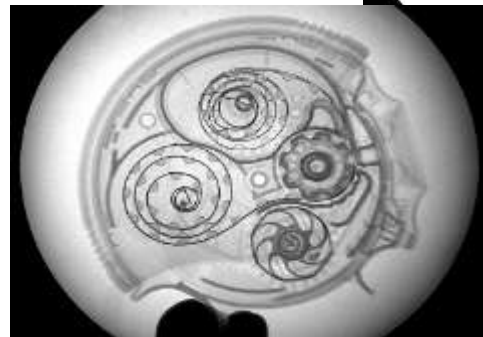

... and complex mechanisms!

X-rays can be used to see more than just bones!

What is Computed Tomography?

- Computed Tomography (or CT) is the process of imaging an object from all directions using penetrating radiation (e.g. X-rays) and using a computer to reconstruct the internal 3-D structure of the object from the intensity values in the projected images.
- It is the process used in a medical CT scanner, though in our case we keep the source and detector stationary and rotate the object. Hospital patients might complain if we did this to them!

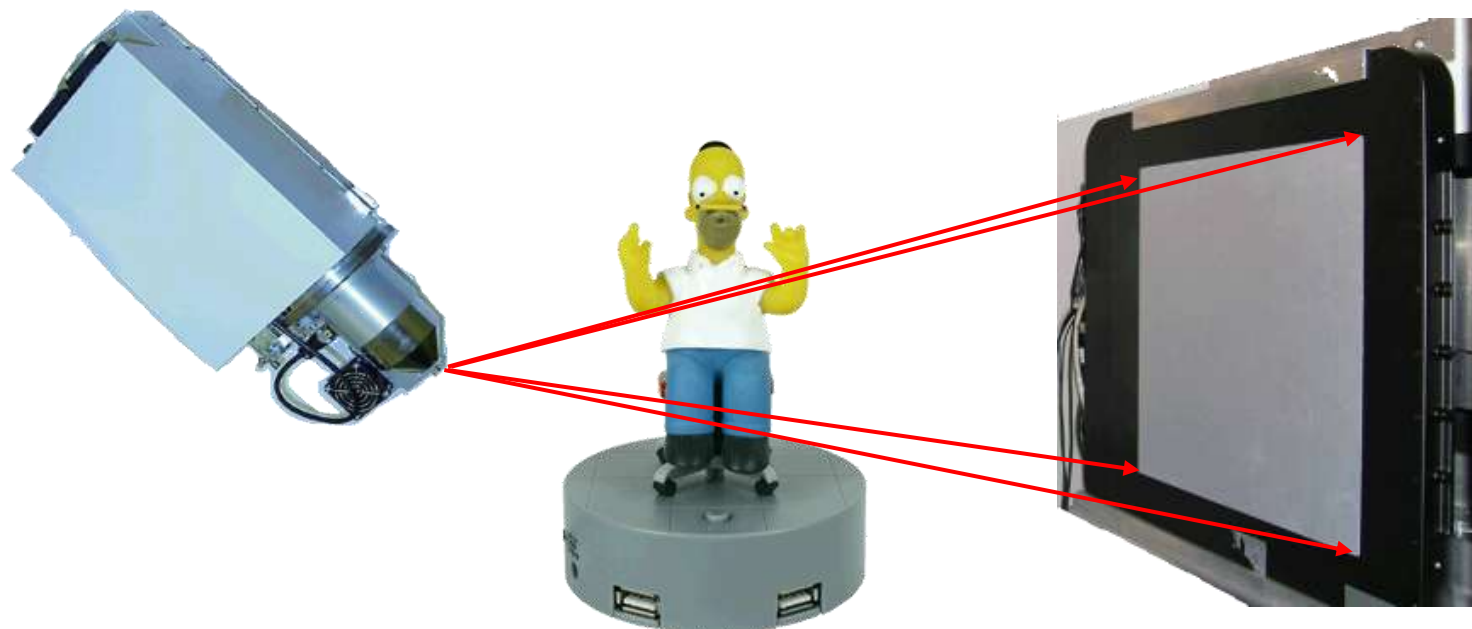

CT requires us to penetrate the object with X-rays from all directions:

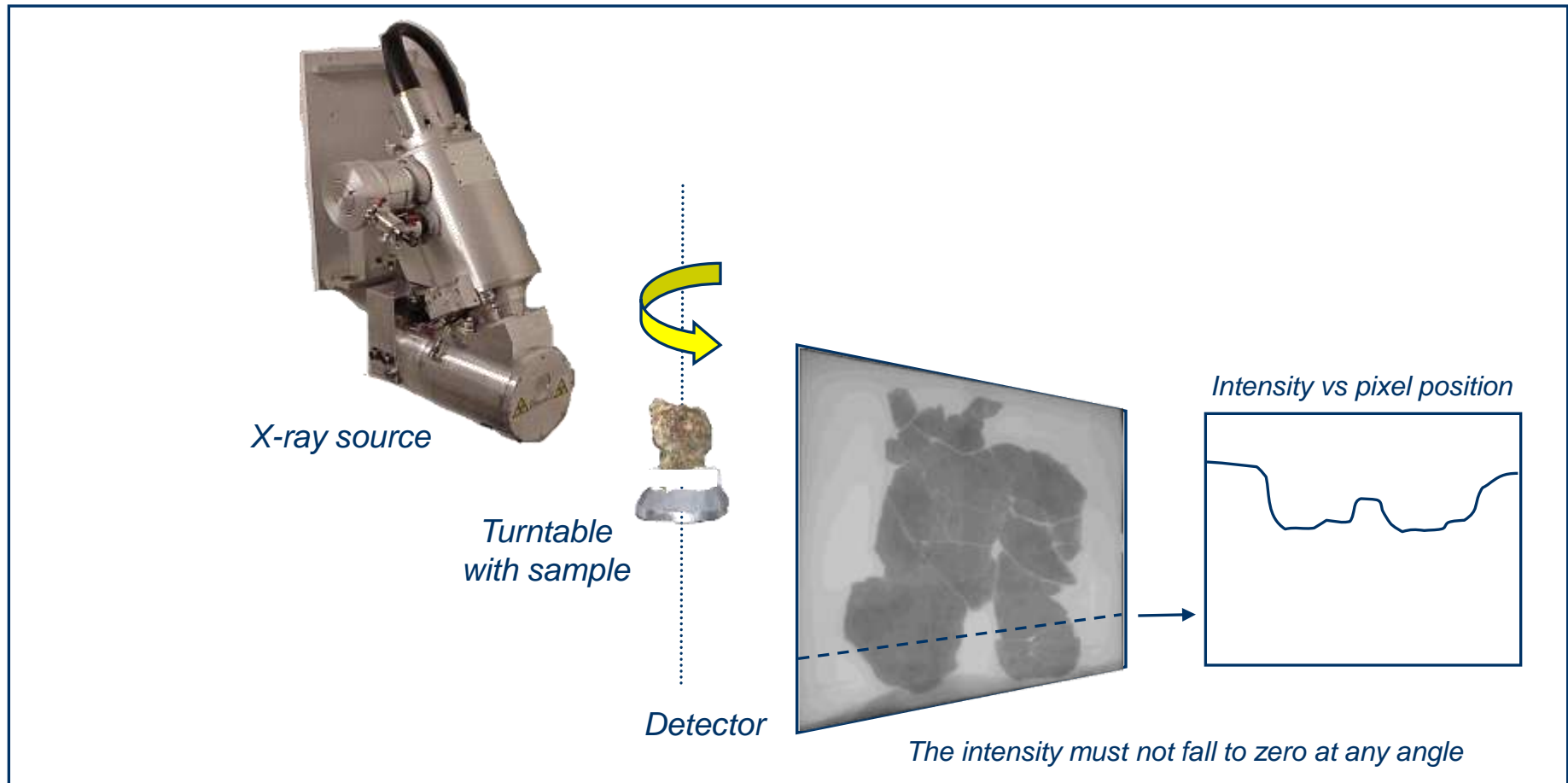

CT requires us to penetrate the object with X-rays from all directions:

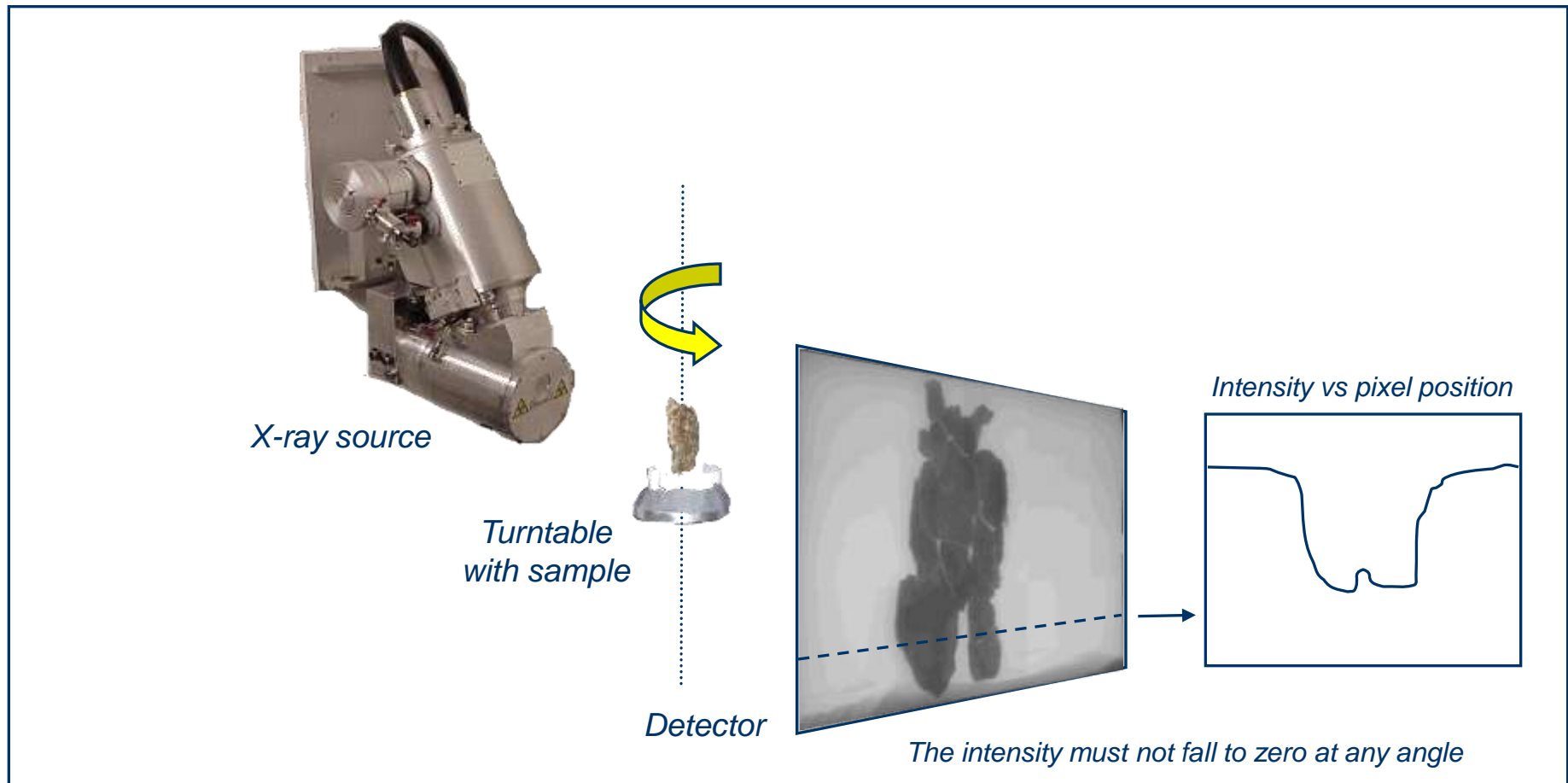

CT requires us to penetrate the object with X-rays from all directions:

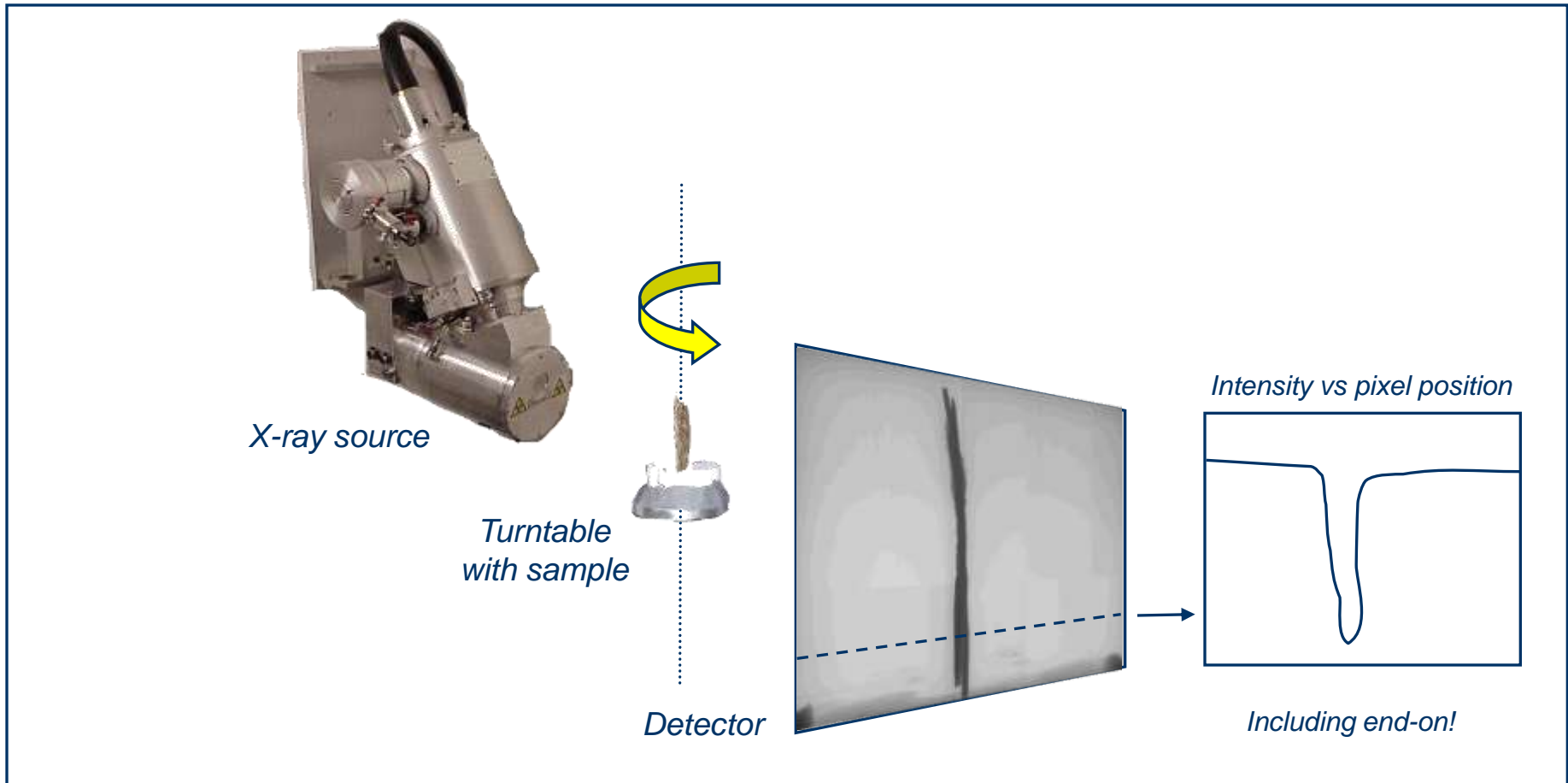

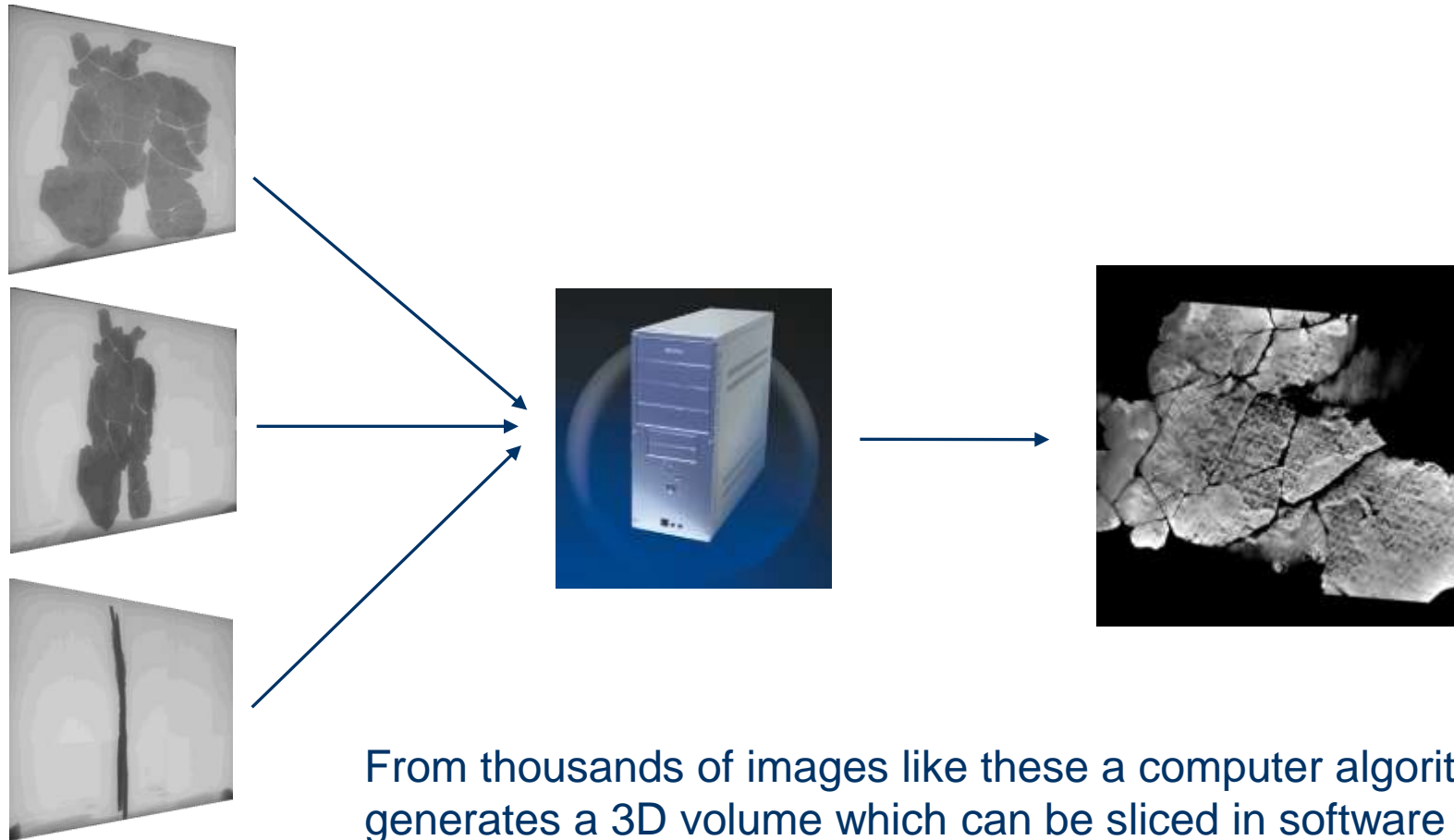

From thousands of images like these a computer algorithm generates a 3D volume which can be sliced in software to reveal details hidden under the corrosion.

But how does Computed Tomography (CT) actually work?

- First we process each of the images (using a filter) to remove the blurring which simply projecting them through the volume would cause.
- Then we project them through the volume, adding in one image after another at the rotation angle it was collected at.
- For each rotation angle, the intensity of the pixel (point in the image) on to which each point in the volume (voxel) projects (draw a line from the source through the voxel to the detector) is added into the volume.
- At the end of all the projection angles the volume is complete.

But how does Computed Tomography (CT) actually work?

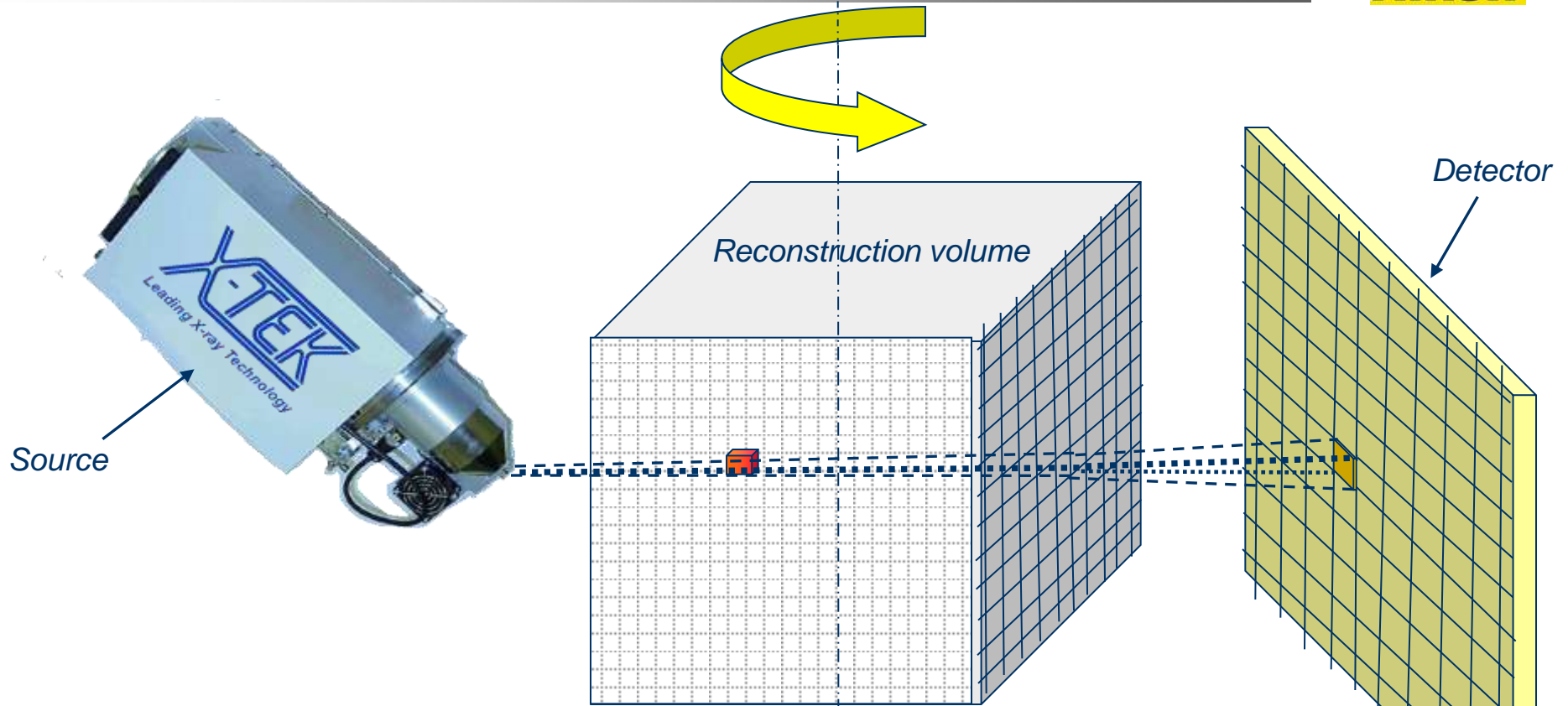

Each voxel is projected on to the pixel that a line from the source through that voxel hits. The intensity of this pixel is added into the voxel. This is repeated for all images. So for 3000 images, each of the billion or so voxels is processed 3000 times. That's why it used to take a long time to reconstruct CT volumes! (Typically 1 hour in 2005.)

But how does Computed Tomography (CT) actually work?

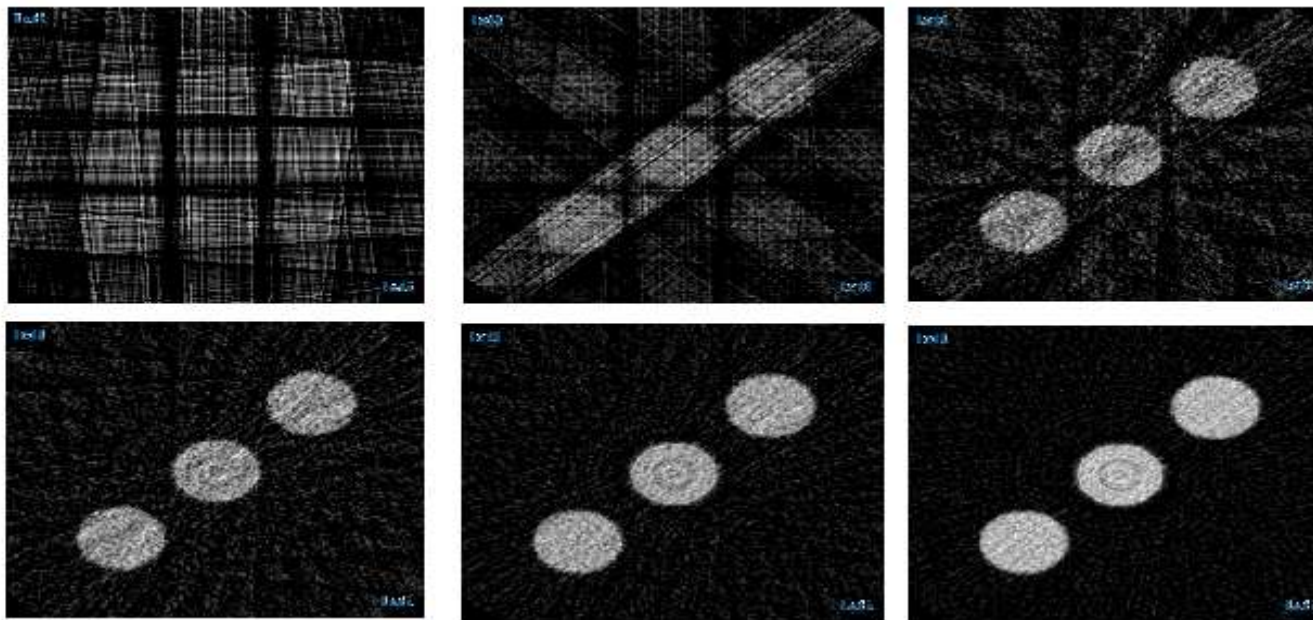

Horizontal slices through a CT volume as projections are added:
Left – right: top: 4, 8, 16, bottom: 32, 64, 128 images added.

How many images do we need to collect for a CT scan?

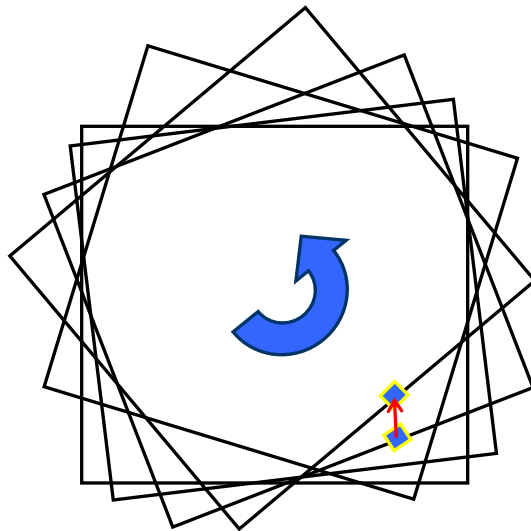

The displacement of an edge pixel from one angle to the next must be no more than the size of one voxel (=3D pixel) in the volume.

For a good quality CT volume we need 1000s of projection images.
To collect these in a reasonable time we used continuous rotation.
Typical scans were 20 mins (1500 images) & 40 mins (3000 images).

Previous X-ray studies of the Mechanism:

- 1971: First radiographed (on film) by Price – model made.
- 1990: X-ray laminography by Michael Wright – new model made*.
- 2005: New X-ray 3D CT inspection by Tony Freeth / Mike Edmunds (a collaboration of Athens Kapodistrian University, University of Thessaloniki, Cardiff University, X-Tek Systems Ltd, Hewlett Packard – funded by the Leverhulme Trust).

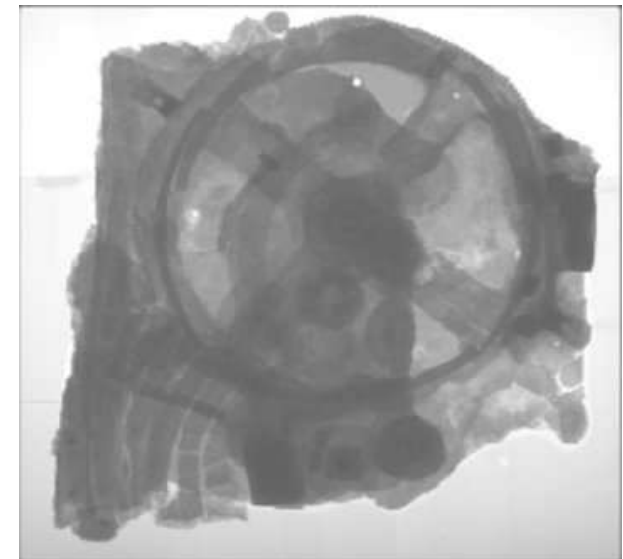

An early radiograph of Fragment A on film by Price (1970).

* Michael Wright “Understanding the Antikythera Mechanism”, Athens Press Conference, October 2005



Model of the mechanism, in the National Archaeological Museum in Athens, made by Derek de Solla Price from early X-ray film images

Michael Wright, formerly of the Science Museum, London, showing Tony Freeth his hand-built reconstruction of the Antikythera Mechanism in Athens, 2006.

Wright and Alan Bromley performed laminography on many of the fragments in 1980 and Wright has since decoded much of the mechanism's structure.





Tony Freeth,
London



Mike Edmonds,
Cardiff Univ.



Xenophon, Yanis & Agamemnon,
Athens Univ.



John Seiradakis,
Thessaloniki Univ.

The New Team



Some of the X-Tek team



The HP team

And the staff of the National Archaeological Museum, Athens



Material: Corroded bronze. Size of largest fragment: $\approx 120\text{mm}$.

For solid bronze:

Each mm reduces the X-ray intensity at 200kV by 4x \therefore Transmission through 120mm $\approx 10^{-70} \%$

At 400kV this drops to 2x \therefore Transmission through 120mm $\approx 10^{-37} \%$

We were hoping for a lot of corrosion!

But Nikon/X-Tek runs an X-ray CT inspection service...



Nikon Metrology NV | Europe

Search

Global Site

Home Products Applications Information Center News Events Support Where To Buy About

Products > X-ray and CT Inspection > CT Inspection services > CT inspection services

X-ray & CT INSPECTION SERVICES



Request Information

Choose Your Region

Europe and others

Submit

Quick Product Finder

All Products

Quick Application Finder

All Applications

Overview

Contract services for X-ray and CT inspection

If you are manufacturer of components or assemblies incorporating plastics, metals, ceramics, electronic components or any combination of these, Nikon Metrology has in-house Inspection centers to perform X-ray and CT contract inspection services for new or existing clients.

Nikon Metrology in-house inspection facilities support aerospace, automotive, Formula1, telecoms, pharmaceutical industries and many more. Samples examined range from the latest hi-tech microchip to a 65million-year-old dinosaur egg. The possibilities are endless!!

Top-class systems operated by experienced users

The full radiography and CT service facilities, including use of 225kV or 450kV microfocus X-ray systems, are operated by experienced application engineers. These specialists will be able to optimize the systems to gain the best X-ray results to identify the issues and may be able to offer both advice and solutions when these faults are detected in the material under



So, why not simply ship the mechanism to Tring...?



But of course, the Mechanism is far too fragile to be transported anywhere, so...



We had to ship the X-ray system to Greece!
All 8 tonnes of it.

X-Tek car park at 1am!



4 days later, after 2500 km of roads, the system arrived in Athens



And was delivered to the National Archaeological Museum



Into the museum through the back door



Unpacking the system

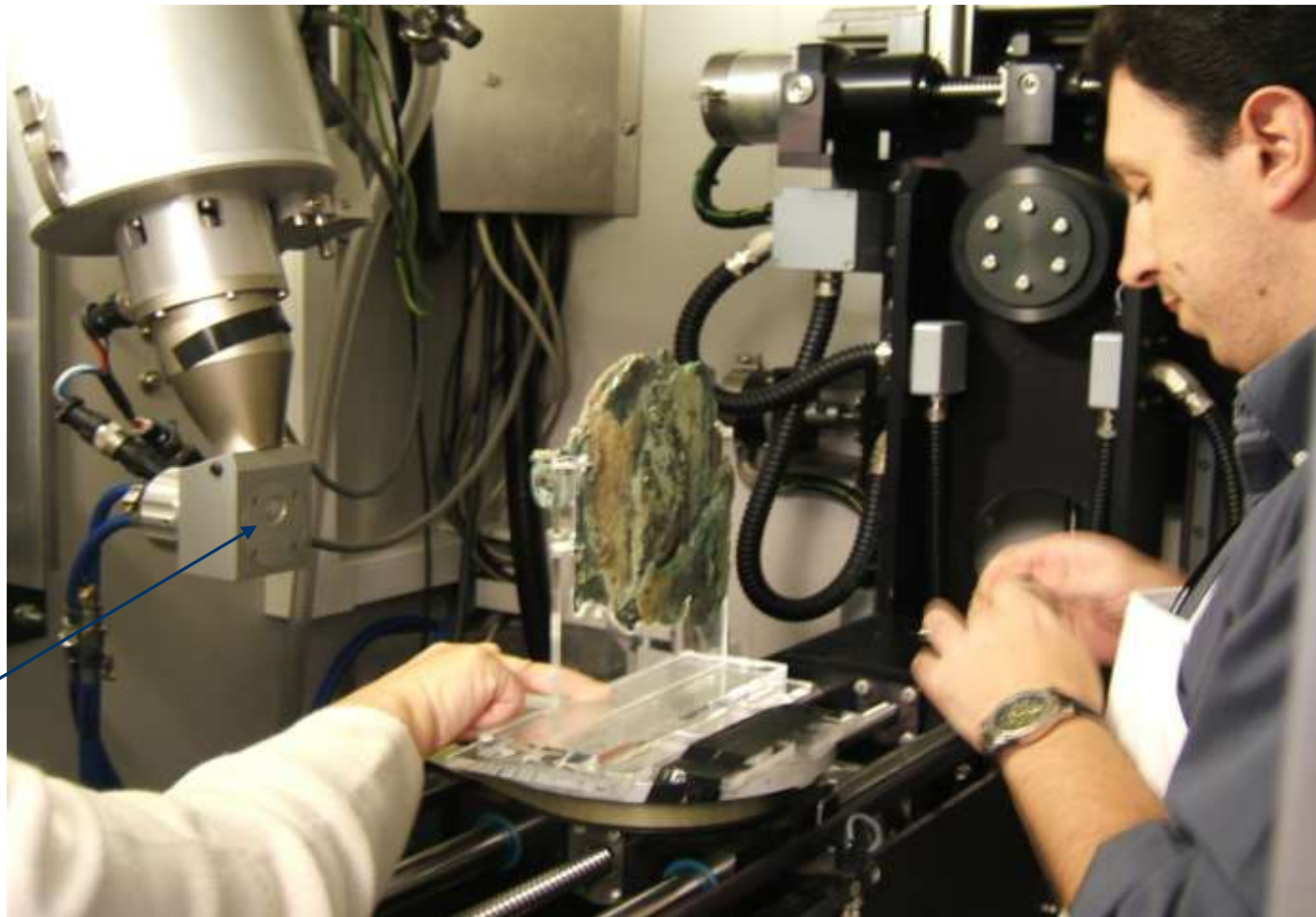

X-ray source

Mounting the fragments



Fragment A

X-Tek's new 450kV microfocus X-ray source:

Most of X-Tek's low energy (up to 225kV) open-tube sources are single ended with the target at ground potential, allowing the sample to be placed very close to the source and so giving very high magnification.

X-Tek's R&D team had worked hard to develop the fore-runner to our new double-ended system which can now generate X-rays up to 450kV whilst maintaining a small focal spot ($\sim 50\mu\text{m}$).

This extra penetrating power would be very helpful in inspecting the larger fragments.



How does X-Tek achieve such a high voltage?

- Most microfocal X-ray sets achieve 225kV with no problem using a target at ground potential.
- X-Tek have taken a second 225kV tube and raised the potential of the target to +225kV to attract the already fast-moving electrons.
- So the total potential that the electrons are accelerated through is 450kV.
- We can now produce X-rays with energies up to 450keV from a region about 50 μ m in size.
- The positive module can be taken off and replaced with a 5 μ m standard lens for inspecting small objects at 225kV or lower.



Mounting the smaller fragments

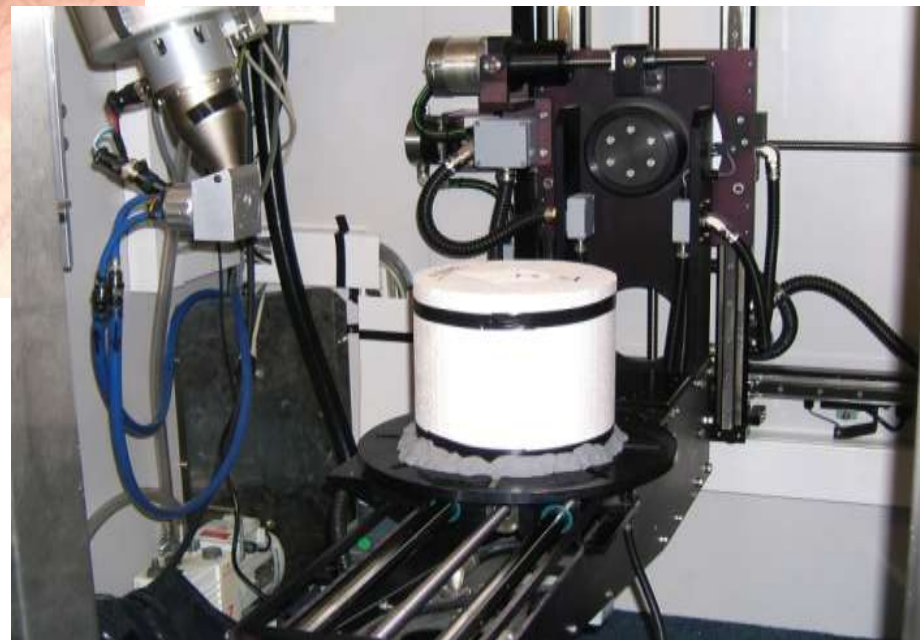



Some of the people involved



Watching the CT data being collected



Visitors to the museum were disappointed during our visit!

Results:

- In just over two weeks we collected 600 GB of data.
- It took several months of effort to count all the teeth on the gears and decipher the text.
- Full results were presented at a conference in Athens in November 2006.
- Here is a summary:

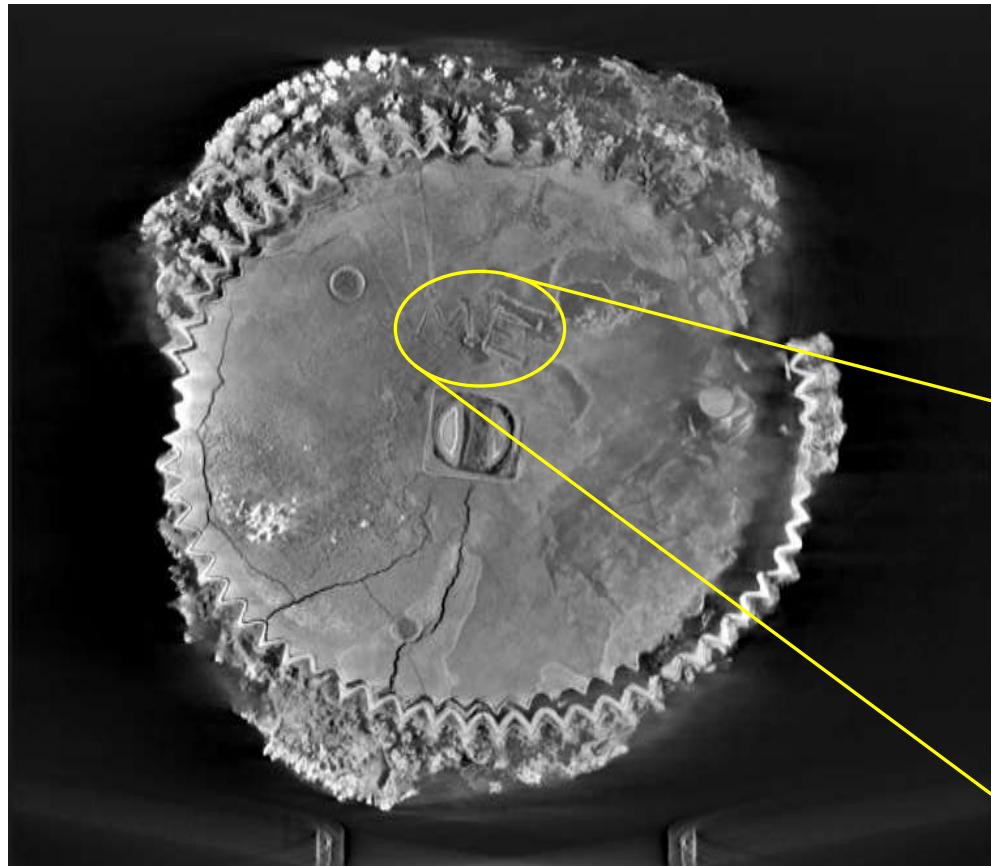

One of dozens of gear wheels inside the mechanism fragments.

Note writing on gear wheel.

Note serifs on the letters!



← ~30mm →

Mike Edmunds didn't believe it was real!



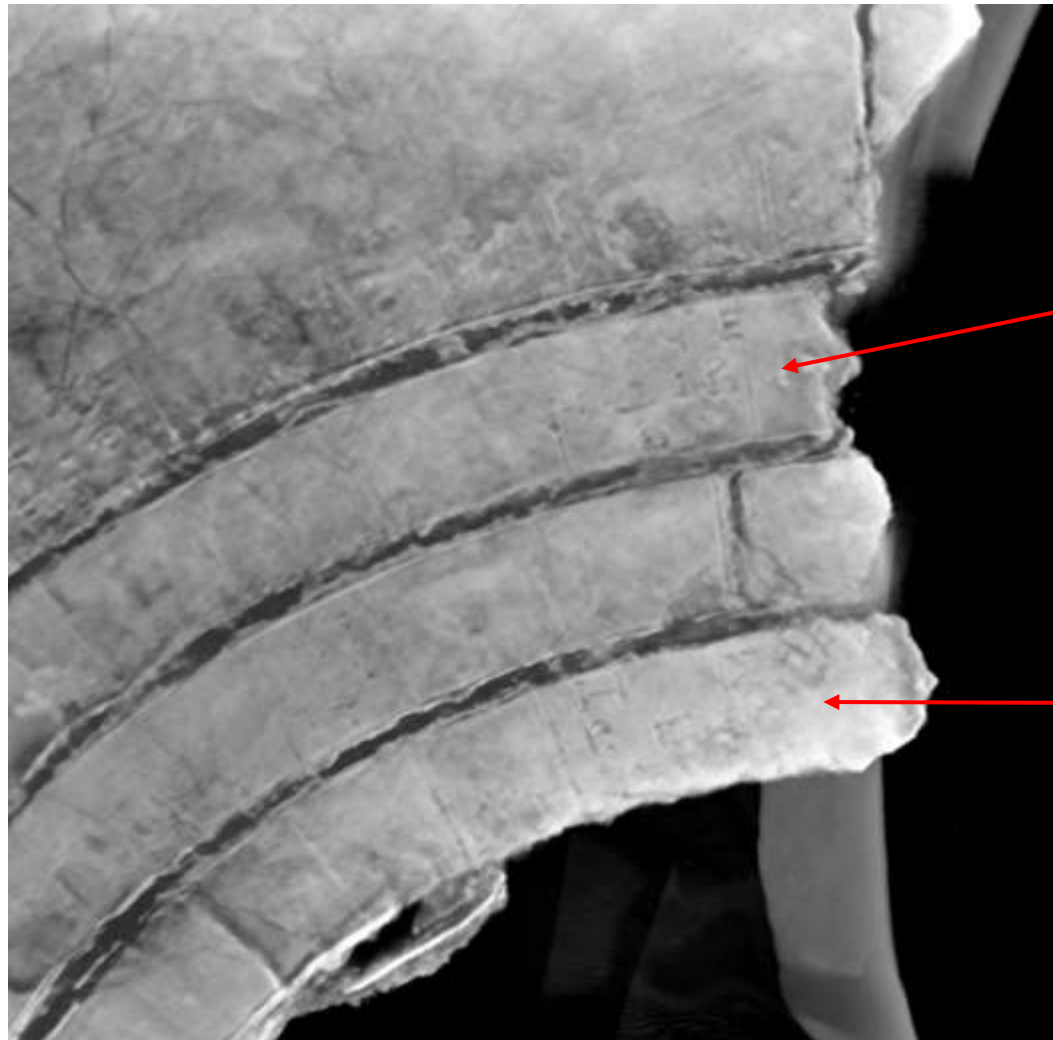

Writing and divisions on the scales

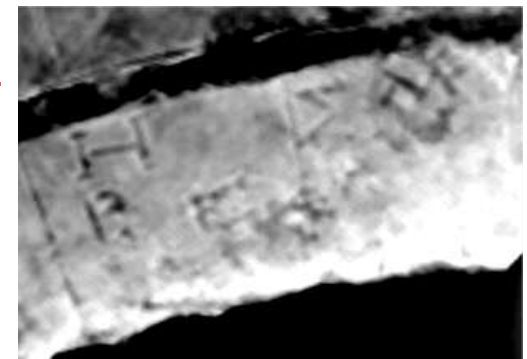

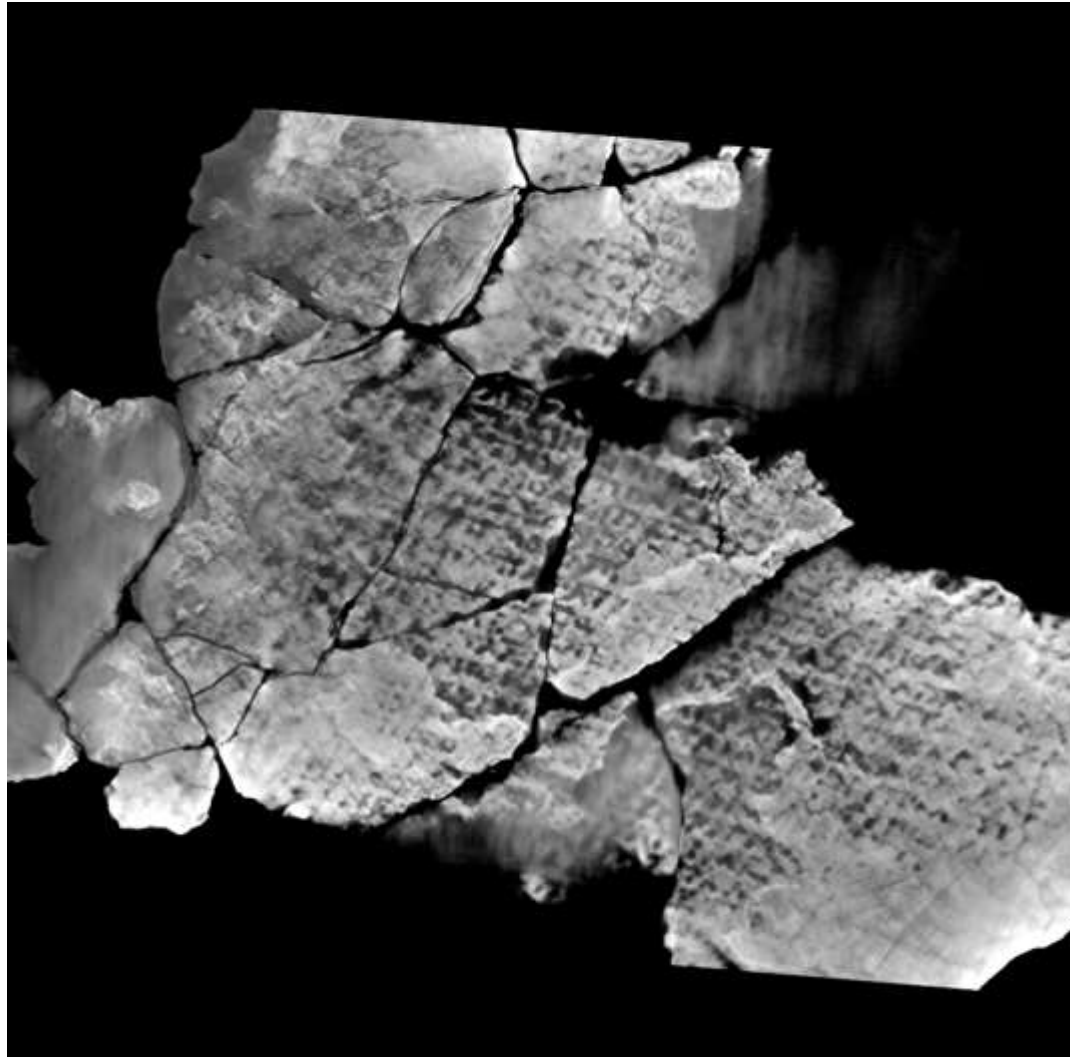

The instruction manual!

How do we see the text in a CT scan when it doesn't show up in a radiograph?

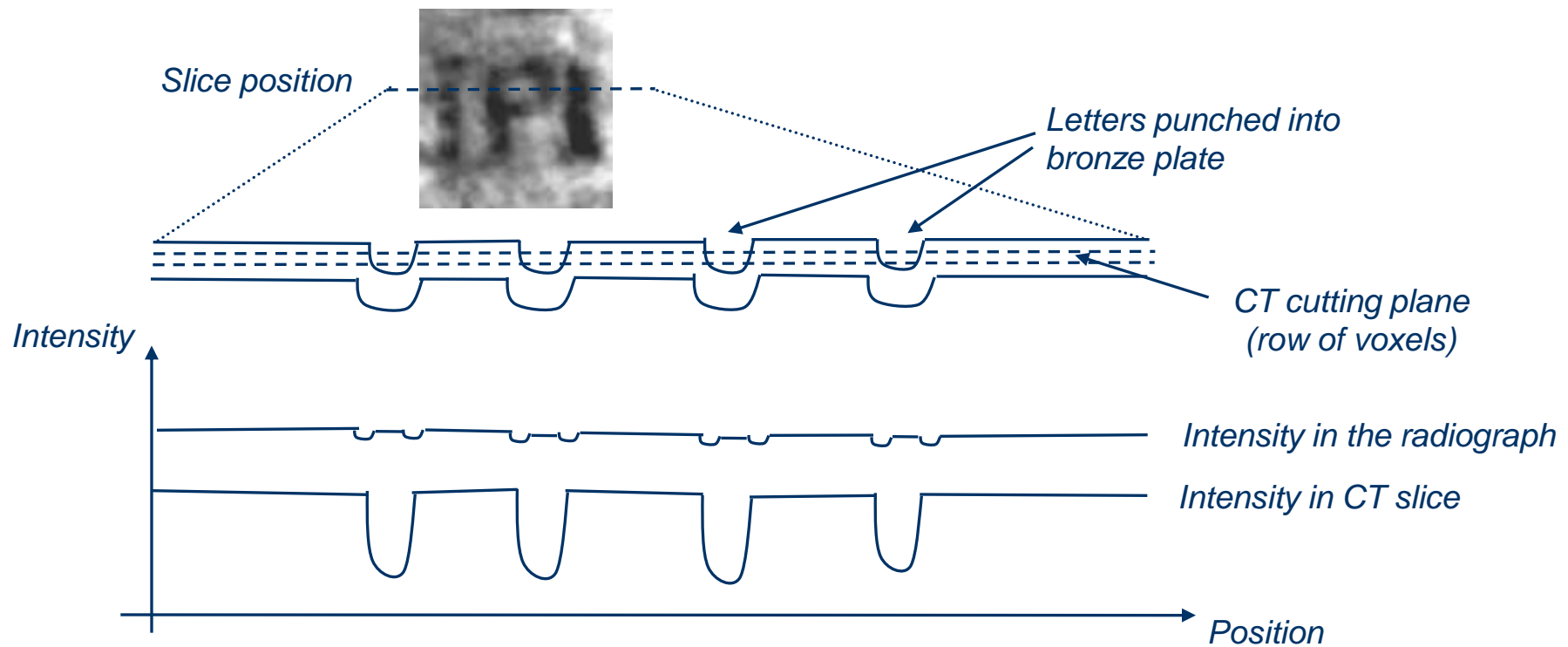

The voxels need to be smaller than the depth of punching of the letters.

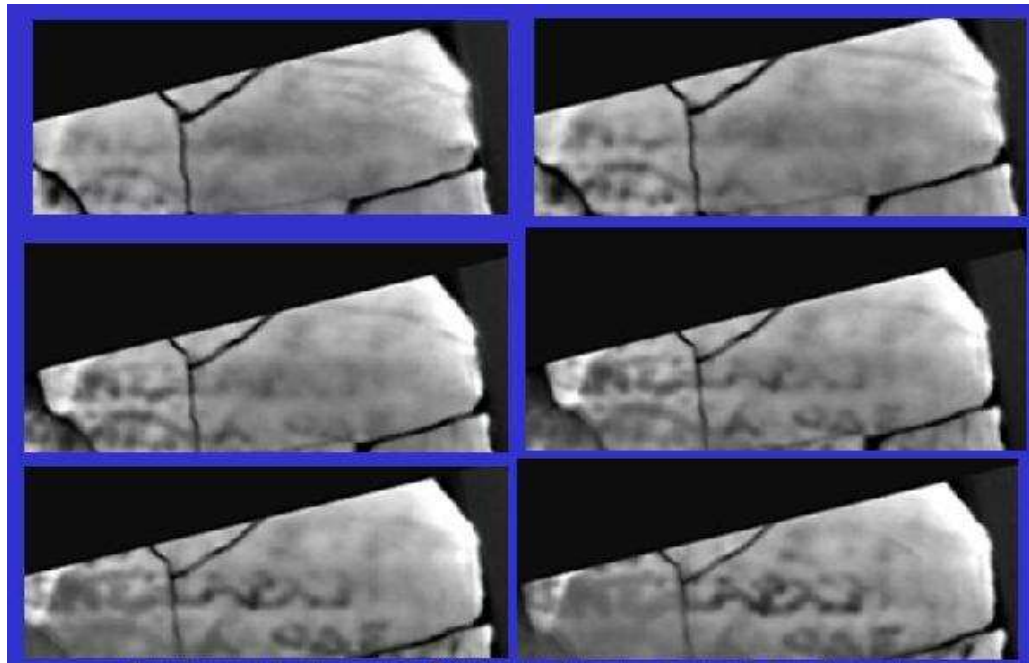

Reading the text is not easy.

The CT slices are flat, the plate is not, so the slice needs to be moved around to see all the text, which can then be pieced together. Each time you move the slice plane, it takes a few seconds for the computer to redraw the image.

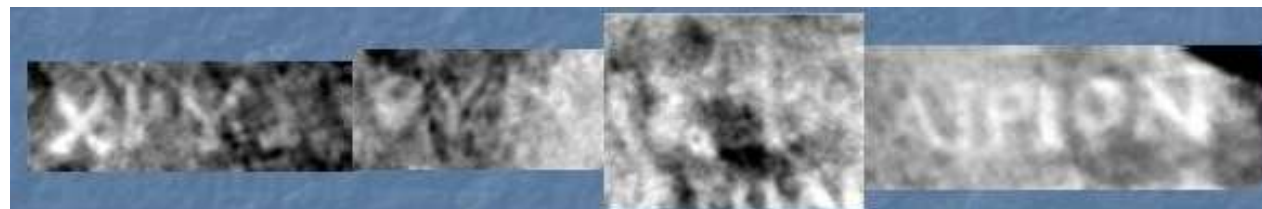

ΧΡΥΣΟΥΝ ΣΦΑΙΡΙΟΝ = chrysoun sfairion (golden sphere)

Front Dials

Zodiac • Egyptian Calendar • Parapegma

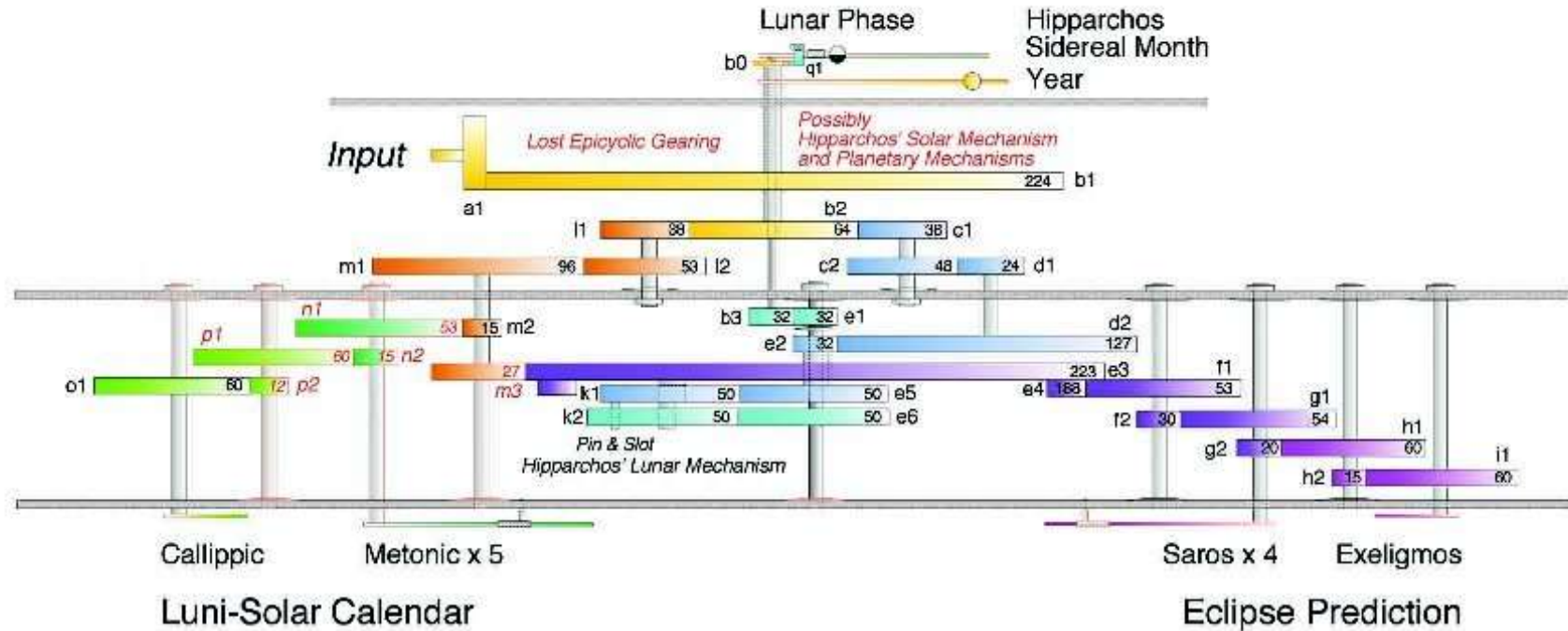

Back Dials

© Antikythera Mechanism Research Project

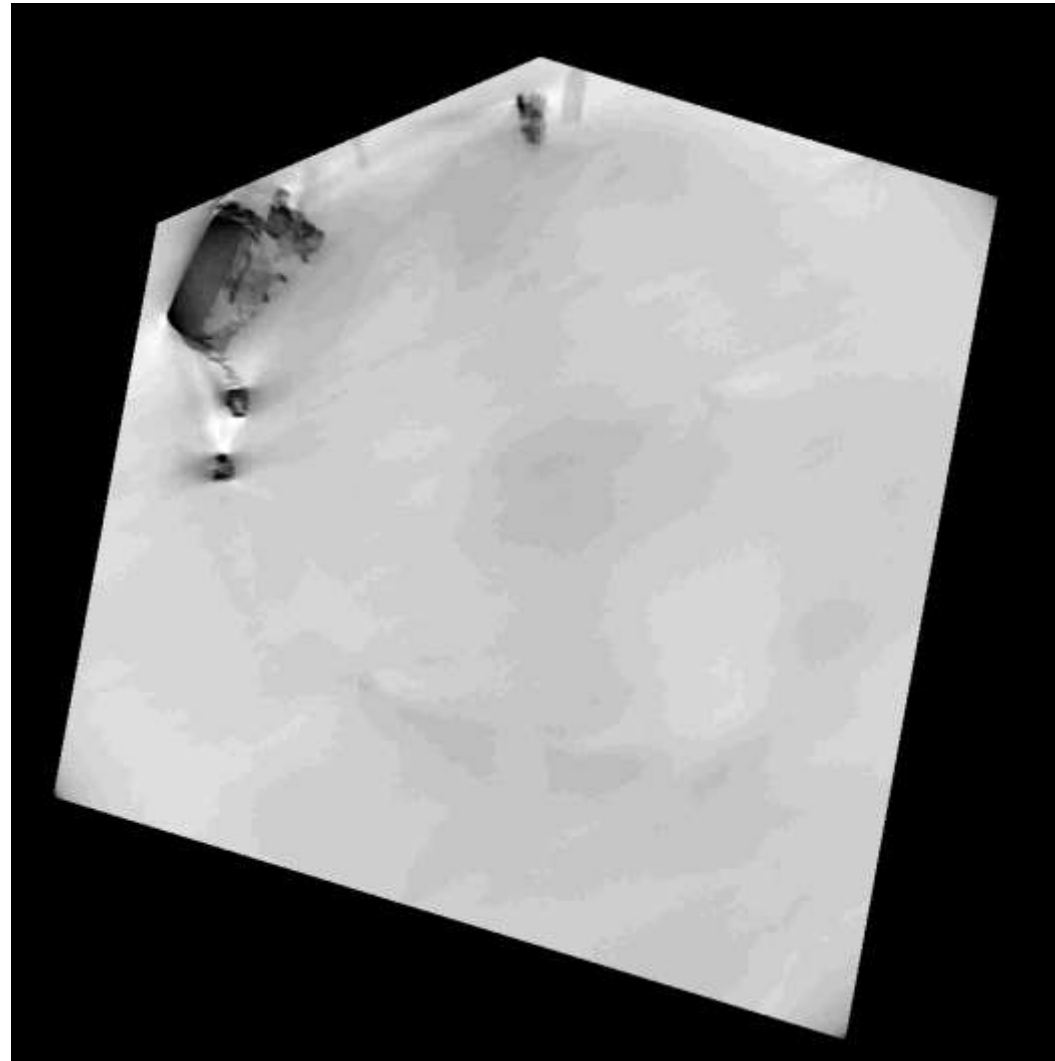

CT slices through
Fragment A from
front to back.

The CT results showed that the Antikythera Mechanism was a complex lunar-solar calendar which modelled the position of the Sun and the Moon (and possibly Mercury and Venus) against the background stars.

Using a set of eccentric gears and a pin and slot mechanism it modelled the elliptical nature of the Moon's orbit around the Earth.

By recording solar and lunar eclipses on a 223-month spiral lunar calendar scale (the length of the Saros, or eclipse-repeat period = 18 years, 11 days, 8 hrs), the Mechanism was able to predict not only the months in which eclipses could occur, but also the time of day. It is not yet clear whether the records were historical (possibly Babylonian dating back to 600BC) or were predicted by the Mechanism itself.

By showing that eclipses in successive cycles occur 8 hours later the Mechanism shows awareness of eclipses happening on the other side of the (round*) world.

* Eratosthenes calculated the diameter of the Earth in about 250BC, and got a value of 13525km (true value = 12757km)

The Saros dial

A slider on the dial pointer rode in the spiral slot and had to be reset every 18 years, 11 days.

Each division represents one lunar month. A month is marked with an H for ΗΛΙΟΣ (= Sun) for a solar eclipse, or a Σ for ΣΕΛΗΝΗ (= Moon) for a lunar eclipse. The hour of the day is also marked. The day itself was either mid-month (full moon) for lunar eclipses or the end of the lunar month (new moon) for solar eclipses.

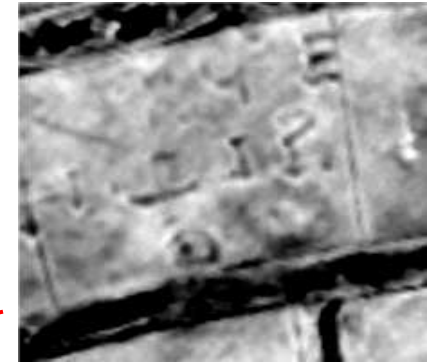
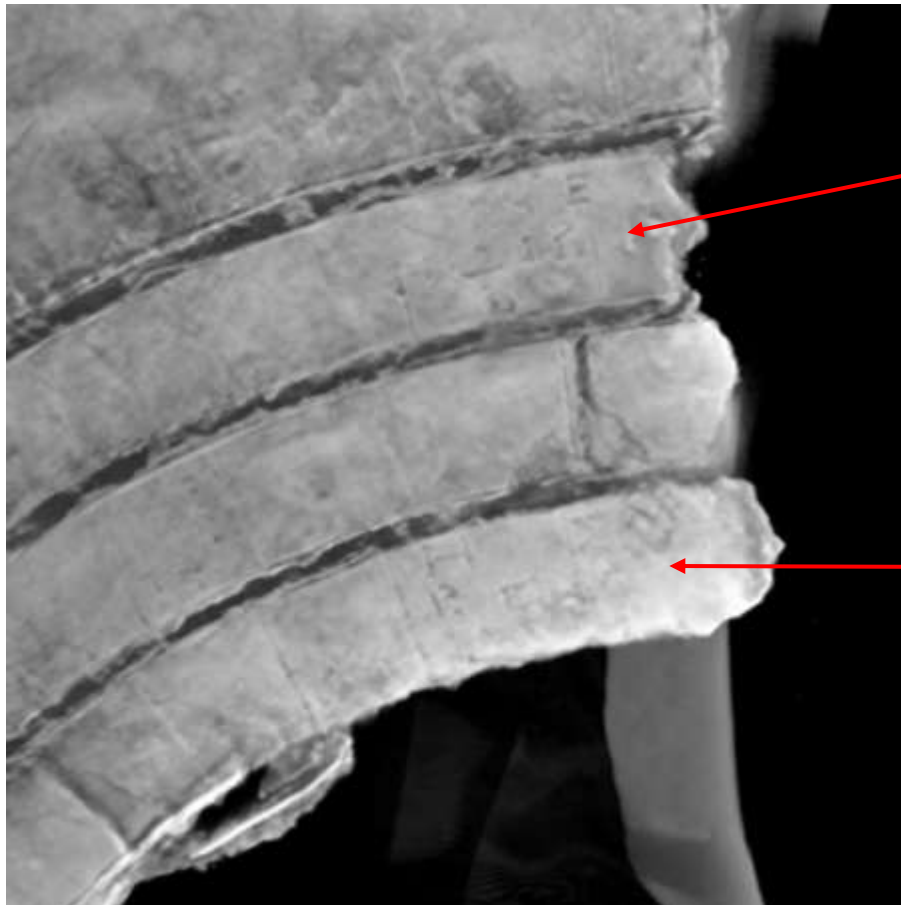

Σ for ΣΕΛΗΝΗ = Moon

H for ΗΛΙΟΣ = Sun



The dial pointer on the spiral Saros dial had a “pointer-follower” which rode in the spiral groove. Every 18 years and 11 days it had to be reset by hand.

Left: Magnified CT slices through Fragment A

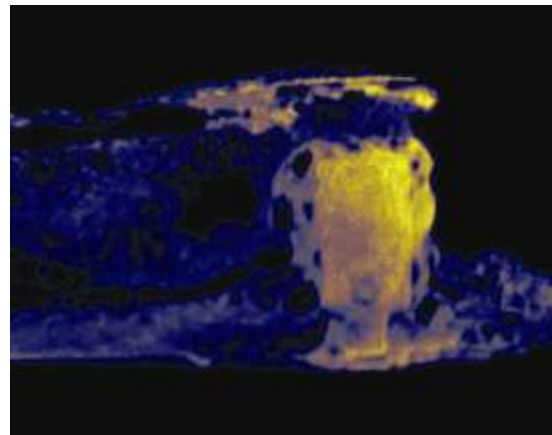

Right: Reconstructed model of pointer-follower

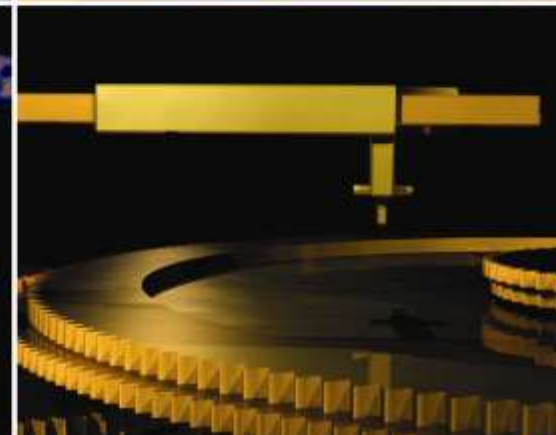
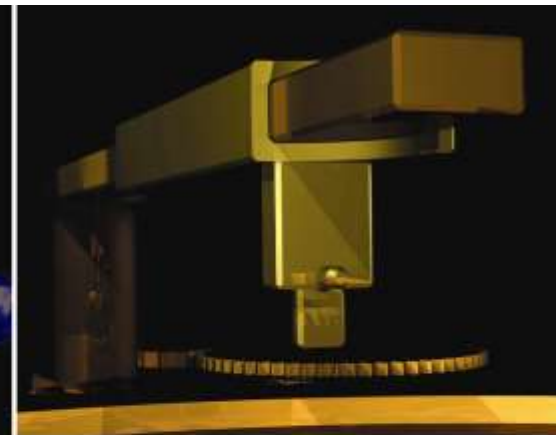
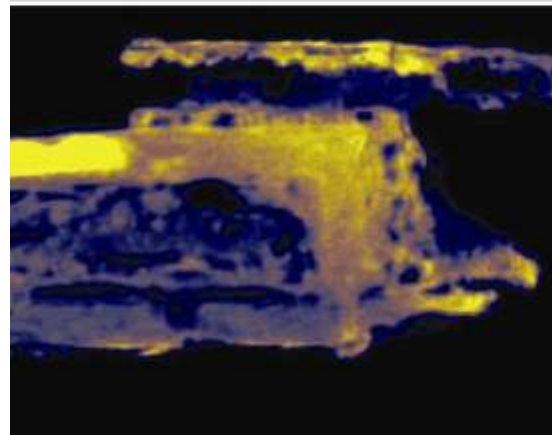

The Moon's elliptical motion is driven by a pin on one gear and a slot in an eccentric gear above this. As the pin slides up & down in the slot, the speed of the gear varies, just as the Moon's speed varies in its elliptical orbit.

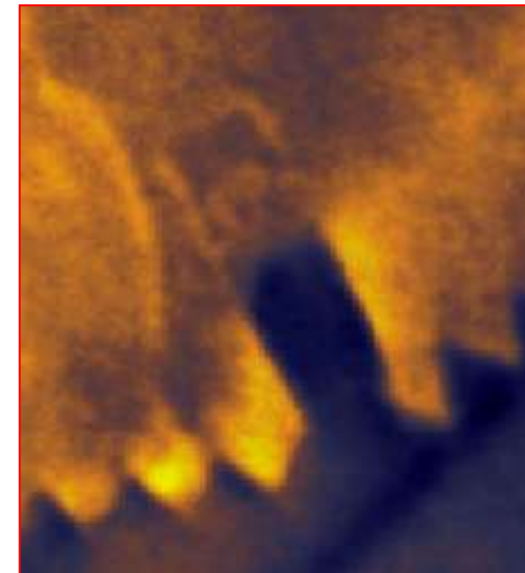
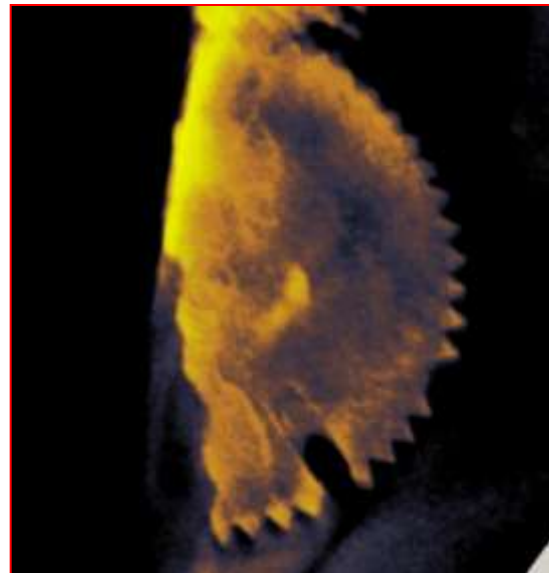
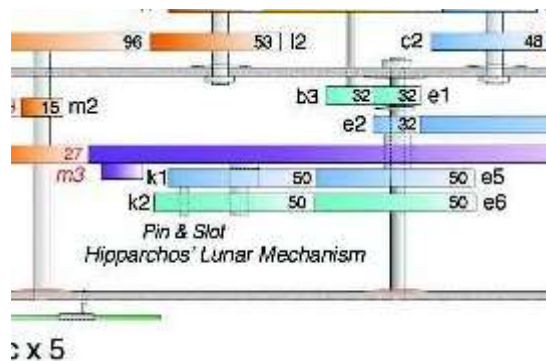
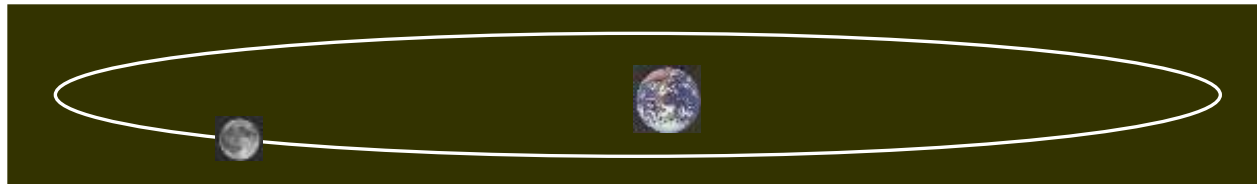

A recreation of the front dials of the Antikythera Mechanism by Dionysis Kriaris



Golden solar sphere

Half-silver, half-black
lunar sphere

A recreation of the Olympiad dial – a 4-year dial showing which games are taking place

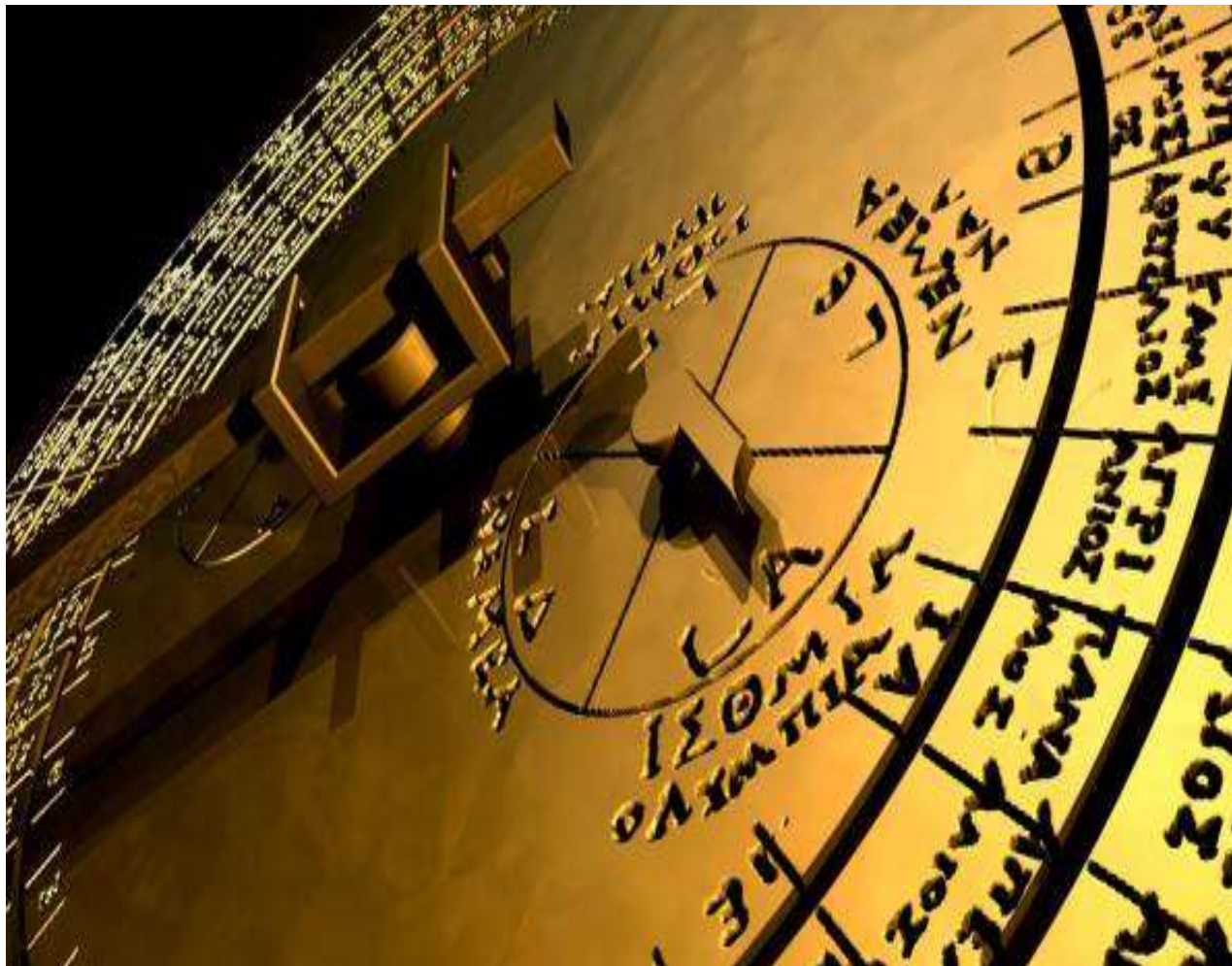

Olympia
Pythia
Nemea
Isthmia

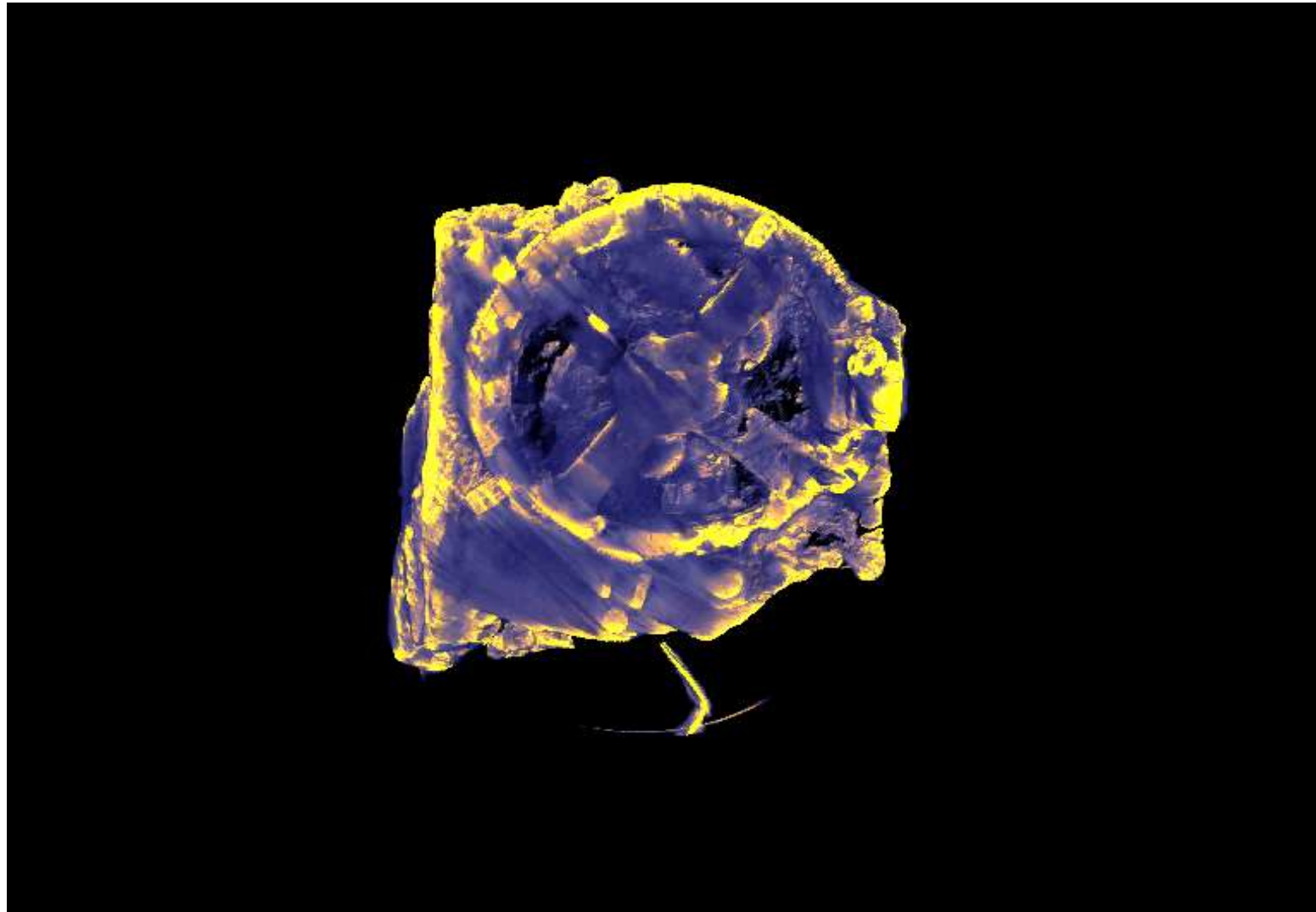

**Thank you to all my colleagues at Nikon Metrology,
especially:**

**Martin Allen
David Bate
Bob Brailey
Alan Crawley
Roger Hadland**

**Ian Haig
Peter Hockley
Andrew Ray
Matt Williams**

And to the Antikythera Research
Project team for inviting X-Tek to
participate.

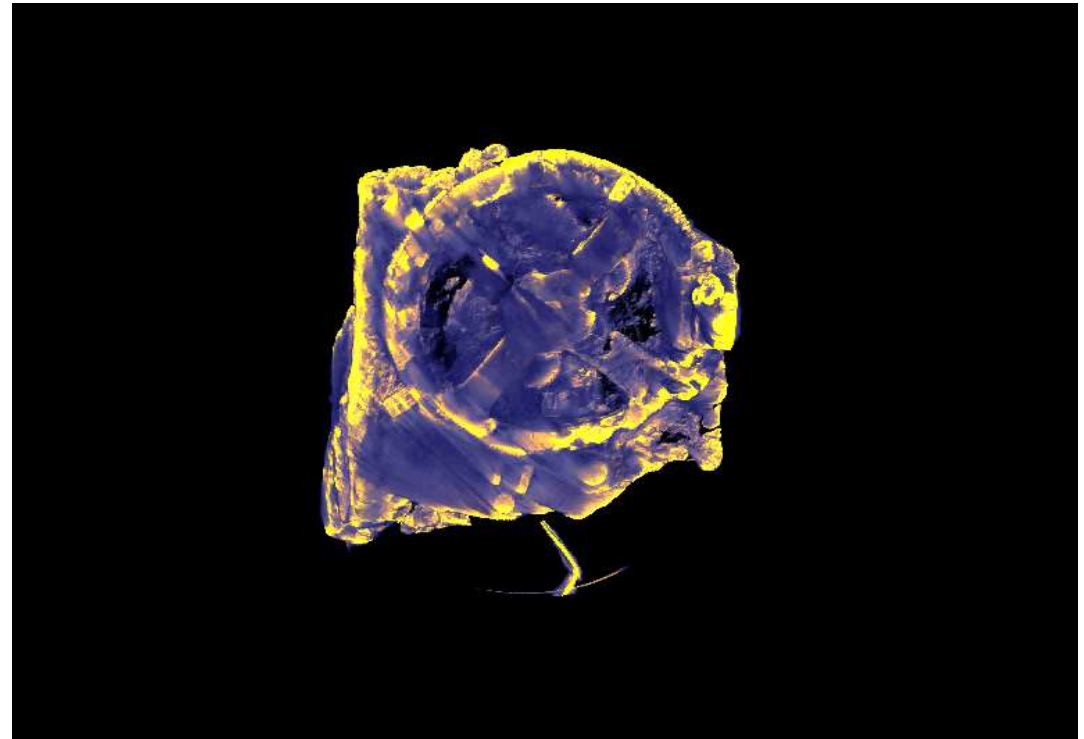

For more info see: <http://www.xtekxray.com/antikythera.htm> &
<http://www.antikythera-mechanism.gr>
For more on Nikon Metrology see: www.nikonmetrology.com



X-ray Tomography of the Antikythera Mechanism

–
Thank you!
Σας ευχαριστούμε!

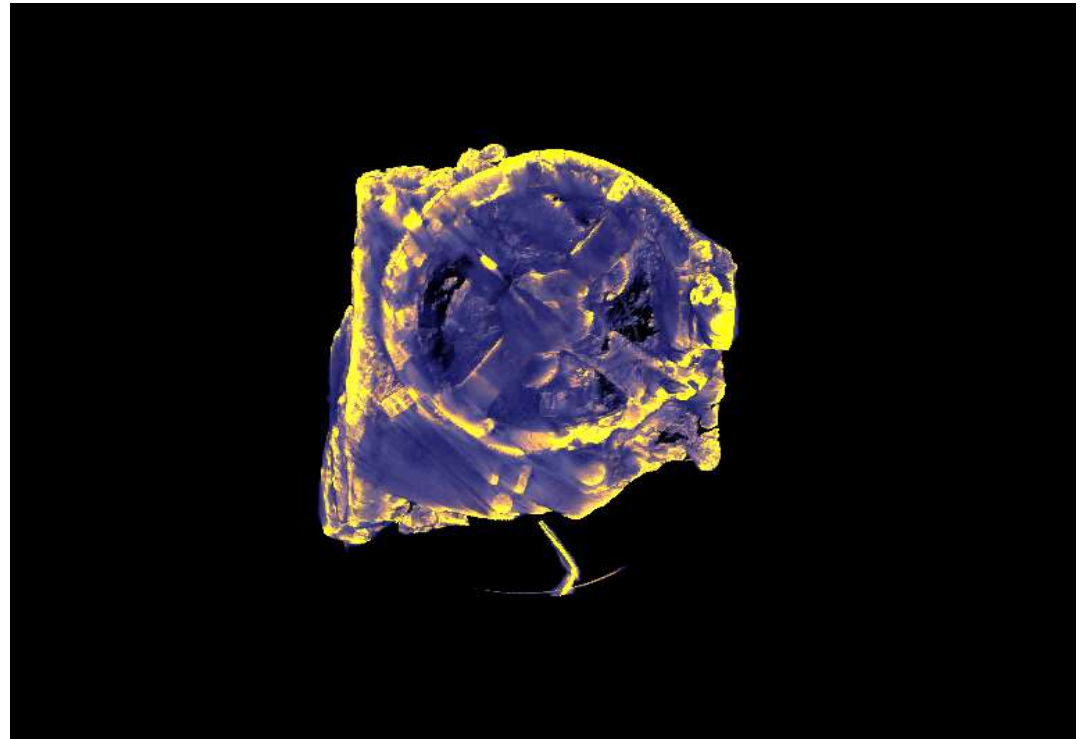

For more info see: <http://www.xtekxray.com/antikythera.htm> &
<http://www.antikythera-mechanism.gr>
For more on Nikon Metrology see: www.nikonmetrology.com